

Republic

STORAGE SYSTEMS, LLC

and **THAT** makes
the difference!

service - integrity - excellence - quality - dependability



Storage **Solutions** Catalog

www.republicstorage.com

Contents

Industrial Clip Shelving 4

Automotive Shelving 15

Rivet Wedge-Lock 16

Original Wedge-Lock 24

Storage Rack 30

Shelving Mezzanine Systems 32

Shop & Office 34

Metal Lumber 36

Lockers 37

At Republic, we've been turning steel into the highest quality storage products on the market for over 100 years. From our early beginning as Berger Manufacturing, to the present Republic Storage Systems, LLC, we've led the industry in product development and innovation, professional engineering services and precise manufacturing processes.

From the time your order is placed with our Customer Service Department to the time it ships from one of our growing number of warehouse facilities, you can be sure that we will supply the service, quality and delivery your business demands.

Everyone at Republic, from president to press operator, has a vested interest in **your success**, which ultimately determines ours. We welcome the opportunity to serve you.

Products

Republic products are manufactured from only the highest quality materials available. Fabrication and finishing processes are carefully monitored to ensure that only high-quality goods reach our customers. Our product line is selected and maintained to include the storage and material handling products that complement your sales and usage needs.

Ordering Information

Republic products are available from a national network of Authorized Distributors. For the names of Distributors near you, call Republic at 800-477-1255 or view our list of District Sales Managers at www.republicstorage.com.

Pricing

Careful management of material and labor costs enables Republic to offer our products at competitive market prices.

Warranty

Republic products come with a full guarantee against defects in materials and workmanship. Our goal is your satisfaction with the look and performance of your storage system.

Regional Warehouses

To better serve customers all over the country, Republic is growing its network of Regional Warehouses. Facilities in Statesville, NC and Reno/Sparks, NV specialize in assembly services and quick shipment of inventory products.

www.republicstorage.com

Our comprehensive website covers everything from product recommendations, to specifications, to important news about Republic. Look for a Republic District Sales Manager, download CAD details, view our latest catalogs or contact Republic by email with special requests.

Engineering Services

From product design to project detailing, our professional engineers work to ensure the structural integrity and quality of every component that leaves our dock. CAD layout services for larger projects are also available.



Characteristics	Applications	Capacity Ranges	Access Method	
Industrial Clip Shelving	<ul style="list-style-type: none"> General to high capacity storage Open and closed storage 1 1/2" vertical shelf adjustability Custom shelf widths 24" - 60" in 1/16" increments 	<ul style="list-style-type: none"> Warehouse Storeroom High-Rise System Multi-Level System Archive/Record Room 	<ul style="list-style-type: none"> Series 2000 <ul style="list-style-type: none"> 275 - 1,250 lbs./shelf Open Flange <ul style="list-style-type: none"> 210 - 580 lbs./shelf 	<ul style="list-style-type: none"> Front access Manual loading Can be used with AS/RS equipment
Automotive Shelving	<ul style="list-style-type: none"> Light duty small parts storage Closed storage Small to medium sized auto parts storage Sliding shelves and dividers to meet changing needs 1 1/2" vertical shelf adjustability 	<ul style="list-style-type: none"> Storeroom Auto Service Center Auto Dealership Auto Parts Store 	<ul style="list-style-type: none"> 150 lbs./shelf 	<ul style="list-style-type: none"> Front access Manual loading
Rivet Wedge-Lock	<ul style="list-style-type: none"> General to high capacity open storage Store self contained items, bulk items 1 1/2" vertical shelf adjustability 	<ul style="list-style-type: none"> Storeroom Retail Sales Floor Warehouse Archive/Record Room Multi-Level System High-Rise System 	<ul style="list-style-type: none"> Standard Units <ul style="list-style-type: none"> 305 - 425 lbs./shelf Bulk Units <ul style="list-style-type: none"> 560 - 1,000 lbs./shelf High-Capacity Bulk Units <ul style="list-style-type: none"> 700 - 1,680 lbs./shelf 	<ul style="list-style-type: none"> Front, side and back access Manual loading
Original Wedge-Lock	<ul style="list-style-type: none"> General to high capacity open storage Store self contained items, bulk items 2" vertical shelf adjustability 	<ul style="list-style-type: none"> Storeroom Retail Sales Floor Warehouse Archive/Record Room High Rise System 	<ul style="list-style-type: none"> Standard Units <ul style="list-style-type: none"> 305 - 425 lbs./shelf Bulk Units <ul style="list-style-type: none"> 560 - 1,000 lbs./shelf High-Capacity Bulk Units <ul style="list-style-type: none"> 700 - 1,680 lbs./shelf 	<ul style="list-style-type: none"> Front, side and back access Manual loading
Storage Rack	<ul style="list-style-type: none"> Store material on pallets Moderate to very heavy loads Open storage 3" vertical adjustability 	<ul style="list-style-type: none"> Warehouse Retail Sales Floor 	<ul style="list-style-type: none"> Upright Frames <ul style="list-style-type: none"> 25,300 lbs. Beams (per pair) <ul style="list-style-type: none"> 7,800 lbs. (Higher capacities available on production components) 	<ul style="list-style-type: none"> Front and back access Mechanical loading
Shelving Mezzanine Systems	<ul style="list-style-type: none"> Utilizes vertical space Double or Triple Tier Multi-level or deck over 	<ul style="list-style-type: none"> Warehouse Storeroom Distribution Facility Manufacturing Facility Archive/Record Storage 	<ul style="list-style-type: none"> Custom designed to meet required capacities and seismic conditions 	<ul style="list-style-type: none"> Front Access Manual Loading Stairs used to access upper levels
Shop & Office	<ul style="list-style-type: none"> Work Bench - basic to highly customized Cabinets - basic to customized interiors Book units - counter and full height 	<ul style="list-style-type: none"> Workstation Personal Effects Storage Office Supply Storage Book Storage 	<ul style="list-style-type: none"> Work Bench Top <ul style="list-style-type: none"> 1,100 lbs. Cabinet Shelf <ul style="list-style-type: none"> 250 lbs. Book Unit Shelf <ul style="list-style-type: none"> 150 lbs. 	<ul style="list-style-type: none"> Front access Manual loading
Metal Lumber	<ul style="list-style-type: none"> Heavy 12 ga. and 14 ga. construction Cut marks on 3" centers Unlimited flexibility and versatility in design capabilities 	<ul style="list-style-type: none"> Custom Shelving Systems Machine Framing Support Framing for Platforms Specialized Shop Equipment 	<ul style="list-style-type: none"> Single Angle <ul style="list-style-type: none"> 700 - 2,910 lbs. based on depth and gauge 	<ul style="list-style-type: none"> Dependent on application
Lockers	<ul style="list-style-type: none"> Secure, lockable storage of personal belongings Ventilation for free air flow Designed to meet specific environment needs 	<ul style="list-style-type: none"> School Corridor/Locker Room Sports Team Room Employee Lounge Park and Recreation Medical/Nursing Facilities 	<ul style="list-style-type: none"> Not Applicable 	<ul style="list-style-type: none"> Front access Front and rear access on special application lockers Manual loading

Industrial Clip Shelving

Republic Industrial Clip Shelving offers complete storage solutions for everything from basic back-room storage to integrated warehouse applications. Basic systems are configured from posts, shelves and compression clips and are enhanced with bins, boxes, dividers and drawers to maximize available space and create efficient storage solutions.

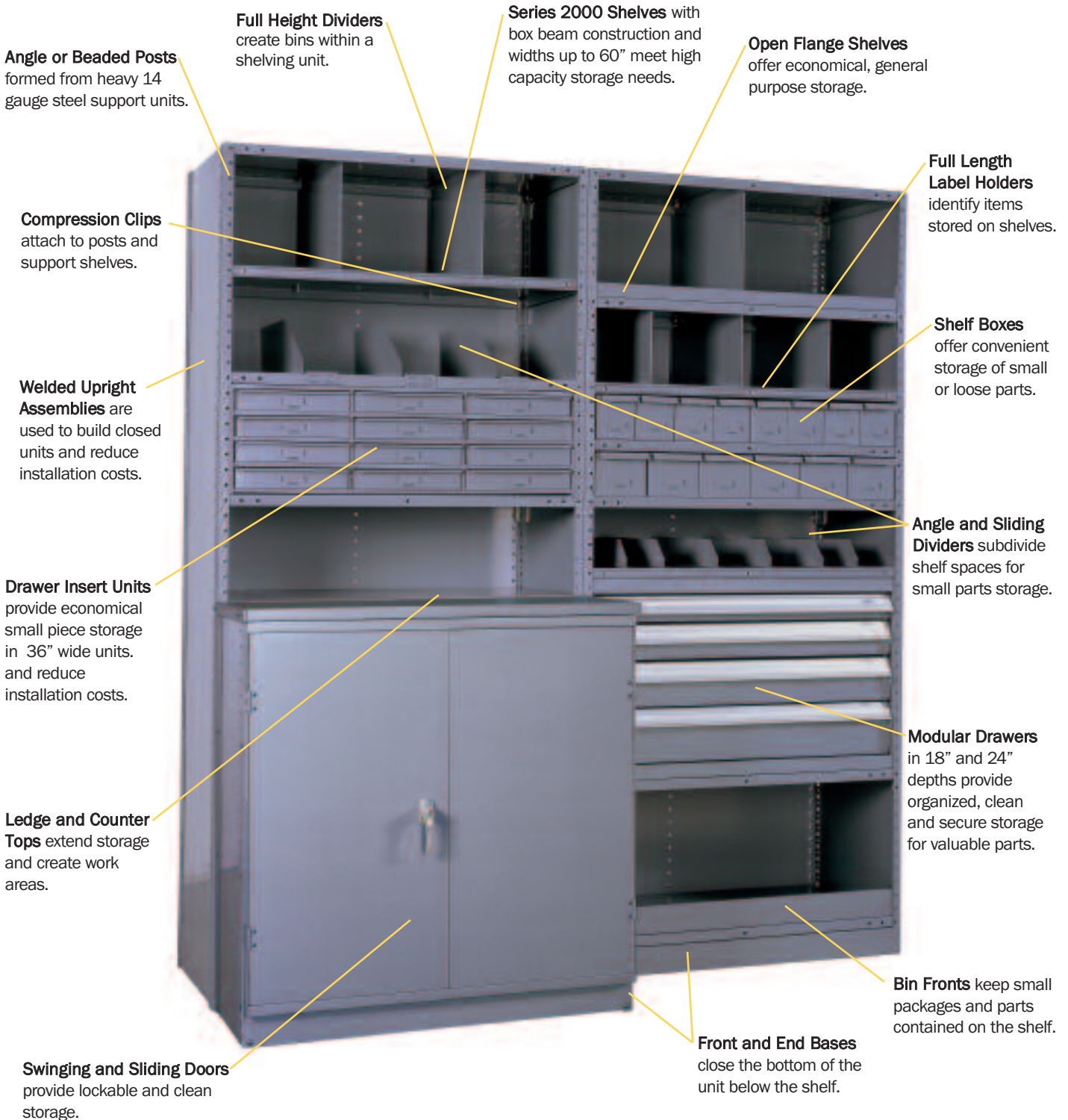

Industrial Clip Shelving

Components

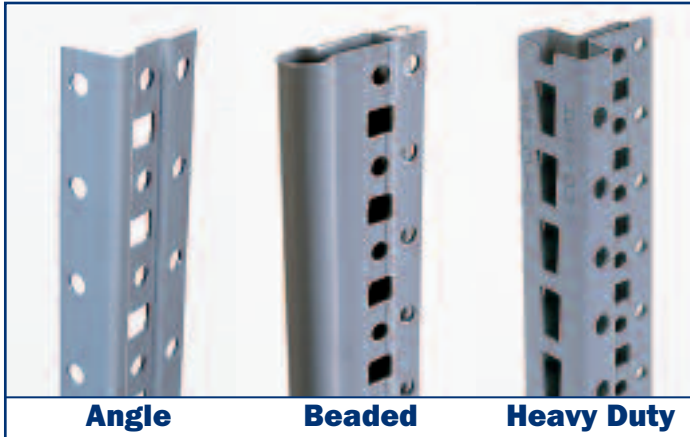

Upright posts for clip shelving units are available in angle, beaded and heavy duty styles to meet a variety of uses. Angle posts are the most economical design, while beaded posts offer clear shelf access. For additional capacity, choose heavy duty posts with a rectangular tube design. Heavy duty posts provide up to four times the capacities of angle and beaded posts.

Available in lengths up to 16'1", posts are roll formed from 14 gauge steel for maximum strength and feature 1½" vertical shelf adjustment. Post splices for all styles can be used for high-rise and multi-level shelving applications.

Post Load Table - ANSI MH 28.1 - 1982				
Shelf Spacing	Single Angle	Double Angle	Beaded	Heavy Duty
	Allowable Axial (Vertical) Load (lbs.) Per Post Type			
12"	2100	4600	4800	7900
18"	1900	4400	4400	7800
24"	1500	4100	3800	7600
30"	1100	3700	3100	7300
36"	800	3200	2200	7000
42"	600	2600	1600	6600
48"	--	2000	--	6200

Post capacities are dependent upon shelf spacing. The carrying capacity of a post increases as shelf spacing decreases. Do not exceed the allowable loads listed.



Compression clips are formed from heavy 13 gauge steel for maximum strength. They engage square holes on upright posts to form a secure support for the shelf. As weight is added to the shelf, compression increases to transfer the load to the posts.

Series 2000 shelves are available in heavy, medium or light duty construction (18, 20 or 22 gauge) to meet a wide range of capacity requirements. Sizes range from 24" to 60" wide and 9" to 36" deep. For custom applications, the width dimension is fully adjustable to match specific storage requirements.

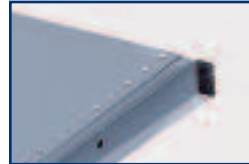

Series 2000

Series 2000 shelves are roll formed with box formations in the front and rear of the shelf for high capacity ratings, without additional reinforcing.



Open Flange

Open flange shelves are strengthened by 3/8" return flanges, offering economical storage for basic applications. On heavy duty requirements, optional reinforcing angles and bars may be added for extra capacity.

Allowable Shelf Loads - ANSI MH 28.1 - 1997				
Shelf Size	Series 2000			Open Flange
	18 gauge	20 gauge	22 gauge	20 gauge
24" x 12"	--	850	500	--
24" x 18"	--	750	500	--
24" x 24"	--	600	500	--
30" x 12"	--	850	500	--
30" x 18"	--	800	500	--
30" x 24"	--	700	500	--
36" x 12"	1100	800	500	390
36" x 15"	1100	825	500	400
36" x 18"	1200	850	500	410
36" x 24"	1250	800	550	450*
36" x 30"	900	600	450	500*
36" x 36"	900	550	350	420*
42" x 12"	900	600	330	280
42" x 15"	900	600	330	290
42" x 18"	950	650	355	290
42" x 24"	1000	650	355	310
42" x 30"	1000	625	340	340
42" x 32"	950	600	330	--
42" x 36"	900	550	300	380
48" x 12"	750	500	275	210
48" x 15"	850	525	285	220
48" x 18"	900	550	300	220
48" x 24"	900	550	300	230
48" x 30"	750	525	285	250
48" x 36"	750	500	275	270
54" x 18"	750	480	--	--
54" x 24"	750	480	--	--
54" x 30"	650	460	--	--
54" x 32"	650	460	--	--
54" x 36"	600	430	--	--
60" x 18"	600	420	--	--
60" x 24"	600	420	--	--
60" x 30"	560	400	--	--
60" x 36"	500	375	--	--

* Loads are limited by the ANSI MH 28.1-1997 safety factor of 1.5.

Do not exceed **uniformly** distributed loads shown. Concentrated load points or impact (dropped) loads could cause shelf failure even though the impact load is less than allowable load shown.

Industrial Clip Shelving



Republic's **open shelving units** are ideal for economical, general purpose storage. They allow light to penetrate a storage area and allow for free air flow around stored materials.

Standard side and back sway braces made from 12 gauge steel are used to stabilize open shelving units. Braces are punched to attach to upright posts with nuts and bolts.

The units shown feature Series 2000 medium duty 20 gauge shelves for standard capacity requirements. Angle post units have angle posts on both front and rear corners. Beaded post units use beaded posts on front corners and angle posts on rear corners. Units include all necessary hardware.

Order one starter unit and the balance as adders to make up a row of shelving. Units are available from stock in #50 Gray and from production in #83 Decorator Tan.



#50 Gray

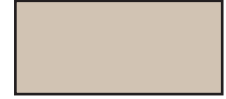

#83 Decorator Tan

Open and closed units ship K.D. (knocked down) from any Republic location.

Open Units 85" High with Series 2000 Shelves

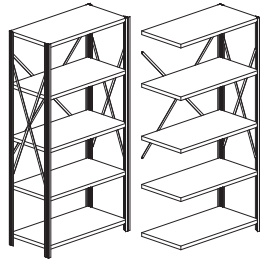

5 Shelves

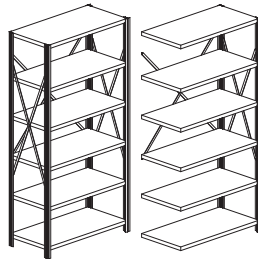

6 Shelves

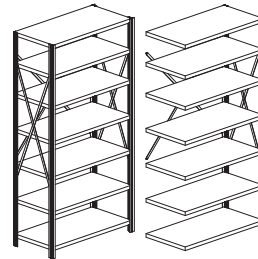

7 Shelves

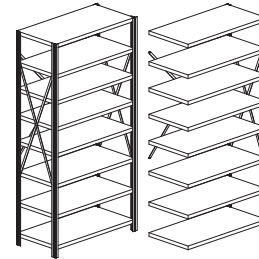

8 Shelves

Angle Post Units

W	D	Capacity	Starter	Adder	Starter	Adder	Starter	Adder	Starter	Adder
36"	12"	800#	DP3001	DP3004	DP3013	DP3016	DP3025	DP3028	DP3037	DP3040
36"	18"	850#	DP3002	DP3005	DP3014	DP3017	DP3026	DP3029	DP3038	DP3041
36"	24"	800#	DP3003	DP3006	DP3015	DP3018	DP3027	DP3030	DP3039	DP3042
42"	12"	600#	DP3211	DP3214	DP3217	DP3220	DP3223	DP3226	DP3229	DP3232
42"	18"	650#	DP3212	DP3215	DP3218	DP3221	DP3224	DP3227	DP3230	DP3233
42"	24"	650#	DP2313	DP3216	DP3219	DP3222	DP3225	DP3228	DP3231	DP3234
48"	12"	500#	DP3101	DP3104	DP3113	DP3116	DP3125	DP3128	DP3137	DP3140
48"	18"	550#	DP3102	DP3105	DP3114	DP3117	DP3126	DP3129	DP3138	DP3141
48"	24"	550#	DP3103	DP3106	DP3115	DP3118	DP3127	DP3130	DP3139	DP3142

Beaded Post Units

W	D	Capacity	Starter	Adder	Starter	Adder	Starter	Adder	Starter	Adder
36"	12"	800#	DP3007	DP3010	DP3019	DP3022	DP3031	DP3034	DP3043	DP3046
36"	18"	850#	DP3008	DP3011	DP3020	DP3023	DP3032	DP3035	DP3044	DP3047
36"	24"	800#	DP3009	DP3012	DP3021	DP3024	DP3033	DP3036	DP3045	DP3048
42"	12"	600#	DP3261	DP3264	DP3267	DP3270	DP3273	DP3276	DP3279	DP3282
42"	18"	650#	DP3262	DP3265	DP3268	DP3271	DP3274	DP3277	DP3280	DP3283
42"	24"	650#	DP3263	DP3266	DP3269	DP3272	DP3275	DP3278	DP3281	DP3284
48"	12"	500#	DP3107	DP3110	DP3119	DP3122	DP3131	DP3134	DP3143	DP3146
48"	18"	550#	DP3108	DP3111	DP3120	DP3123	DP3132	DP3135	DP3144	DP3147
48"	24"	550#	DP3109	DP3112	DP3121	DP3124	DP3133	DP3136	DP3145	DP3148

Foot plates, available separately, are recommended for use on all shelving units to spread loads, prevent damage to floor surfaces, aid in shimming uprights to a plumb condition and allow for anchoring when necessary.

Industrial Clip Shelving

Closed shelving units are used for applications where stored materials require additional protection or containment. They utilize 24 gauge back and side sheets with the basic post/shelf connection for strength and stability. To improve the ease and speed of installation, upright assemblies can be used in place of individual posts and side sheets. End uprights are used at the beginning and end of rows. Intermediate uprights are used between units in a row. Two backs can be used when units exceed 8'1" in height; splices cover the seams on exposed two-piece backs.

The units shown feature Series 2000 medium duty 20 gauge shelves for standard capacity requirements. Welded

upright assemblies are supplied for all closed units. Angle post units use angle posts on both front and rear corners. Beaded post units use beaded posts on front corners and angle posts on rear corners. Units are supplied with front bases to close off the unit below the bottom shelf. All necessary hardware is included.

Order one starter unit and the balance as adders to make up a row of shelving. Units are available from stock in #50 Gray and from production in #83 Decorator Tan.



#50 Gray



#83 Decorator Tan

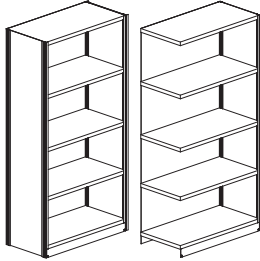
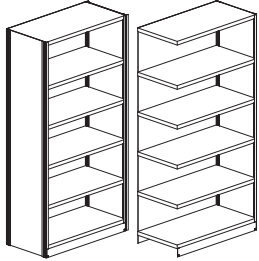
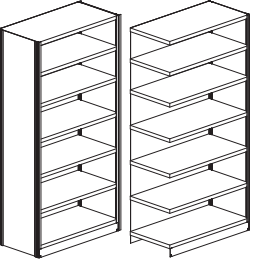
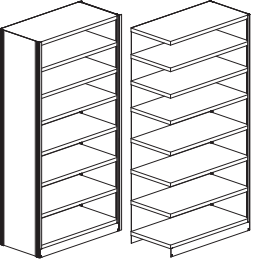

Closed Units 85" High with Series 2000 Shelves										
Angle Post Units			5 Shelves		6 Shelves		7 Shelves		8 Shelves	
W	D	Capacity	Starter	Adder	Starter	Adder	Starter	Adder	Starter	Adder
36"	12"	800#	DP3049	DP3052	DP3061	DP3064	DP3073	DP3076	DP3085	DP3088
36"	18"	850#	DP3050	DP3053	DP3062	DP3065	DP3074	DP3077	DP3086	DP3089
36"	24"	800#	DP3051	DP3054	DP3063	DP3066	DP3075	DP3078	DP3087	DP3090
42"	12"	600#	DP3307	DP3310	DP3313	DP3316	DP3319	DP3322	DP3325	DP3328
42"	18"	650#	DP3308	DP3311	DP3314	DP3317	DP3320	DP3323	DP3326	DP3329
42"	24"	650#	DP3309	DP3312	DP3315	DP3318	DP3321	DP3324	DP3327	DP3330
48"	12"	500#	DP3149	DP3152	DP3161	DP3164	DP3173	DP3176	DP3185	DP3188
48"	18"	550#	DP3150	DP3153	DP3162	DP3165	DP3174	DP3177	DP3186	DP3189
48"	24"	550#	DP3151	DP3154	DP3163	DP3166	DP3175	DP3178	DP3187	DP3190
Beaded Post Units			5 Shelves		6 Shelves		7 Shelves		8 Shelves	
W	D	Capacity	Starter	Adder	Starter	Adder	Starter	Adder	Starter	Adder
36"	12"	800#	DP3055	DP3058	DP3067	DP3070	DP3079	DP3082	DP3091	DP3094
36"	18"	850#	DP3056	DP3059	DP3068	DP3071	DP3080	DP3083	DP3092	DP3095
36"	24"	800#	DP3057	DP3060	DP3069	DP3072	DP3081	DP3084	DP3093	DP3096
42"	12"	600#	DP3331	DP3334	DP3337	DP3340	DP3343	DP3346	DP3349	DP3352
42"	18"	650#	DP3332	DP3335	DP3338	DP3341	DP3344	DP3347	DP3350	DP3353
42"	24"	650#	DP3333	DP3336	DP3339	DP3342	DP3345	DP3348	DP3351	DP3354
48"	12"	500#	DP3155	DP3158	DP3167	DP3170	DP3179	DP3182	DP3191	DP3194
48"	18"	550#	DP3156	DP3159	DP3168	DP3171	DP3180	DP3183	DP3192	DP3195
48"	24"	550#	DP3157	DP3160	DP3169	DP3172	DP3181	DP3184	DP3193	DP3196

Foot plates, available separately, are recommended for use on all shelving units to spread loads, prevent damage to floor surfaces, aid in shimming uprights to a plumb condition and allow for anchoring when necessary.

Industrial Clip Shelving



Bin units offer convenient, organized storage of small parts for parts stores, tool departments, office supply areas, warehouses, assembly areas and a host of other storage applications.

Units are closed to contain and protect items and feature welded upright assemblies with angle posts, sturdy backs and Series 2000 20 gauge shelves for standard capacity requirements.

The full height dividers that create the bins are formed from 22 gauge steel with a beaded end for clear, safe access to bin contents. Dividers can be repositioned on the shelf to accommodate changing storage requirements. Units also include front bases to prevent

debris accumulation under units. Shelf boxes and bin fronts can be added to units when better containment of stored parts is needed.

Order one starter unit and the balance as adders to make up a row of shelving. Units are available from stock in #50 Gray and from production in #83 Decorator Tan.



#50 Gray



#83 Decorator Tan

Units are shipped K.D. (knocked down) from all Republic locations.

Bin Units 85" High with Series 2000 Shelves			 10 Shelves 9 Openings		 8 Shelves 14 Openings		 8 Shelves 21 Openings		 9 Shelves 29 Openings	
W	D	Capacity	Starter	Adder	Starter	Adder	Starter	Adder	Starter	Adder
36"	12"	800#	DP1813	DP1816	DP1097	DP1100	DP1133	DP1136	DP1145	DP1148
36"	18"	850#	DP1814	DP1817	DP1098	DP1101	DP1134	DP1137	DP1146	DP1149
36"	24"	800#	DP1815	DP1818	DP1099	DP1102	DP1135	DP1138	DP1147	DP1150
			 9 Shelves 32 Openings		 10 Shelves 36 Openings		 11 Shelves 37 Openings		 11 Shelves 43 Openings	
W	D	Capacity	Starter	Adder	Starter	Adder	Starter	Adder	Starter	Adder
36"	12"	800#	DP1157	DP1160	DP1169	DP1172	DP1819	DP1822	DP1191	DP1194
36"	18"	850#	DP1158	DP1161	DP1170	DP1173	DP1820	DP1823	DP1192	DP1195
36"	24"	800#	DP1159	DP1162	DP1171	DP1174	DP1821	DP1824	DP1193	DP1196

Foot plates, available separately, are recommended for use on all shelving units to spread loads, prevent damage to floor surfaces, aid in shimming uprights to a plumb condition and allow for anchoring when necessary.

Industrial Clip Shelving

Bin fronts made from 18 gauge steel are an excellent addition to bin units to accommodate small parts storage. The top and bottom are flanged so the bin front may be used as a card holder.

Heights include 1 1/2", 3", 4 1/2" and 6". Bin fronts are available from stock in #50 Gray and from production in #83 Decorator Tan.

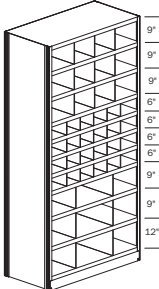
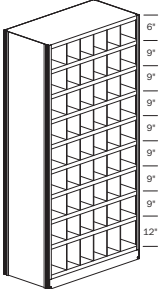
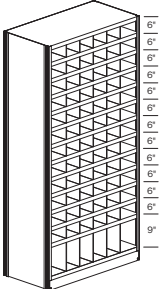
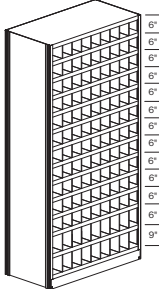
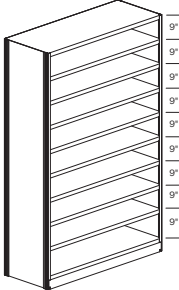
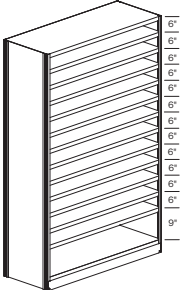
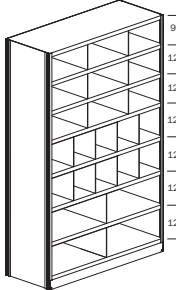
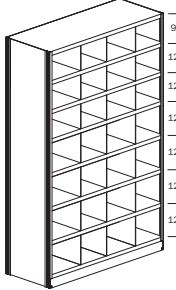
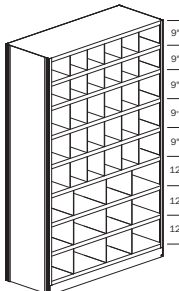
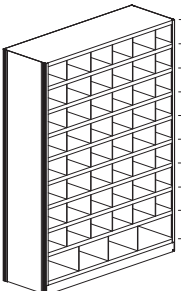
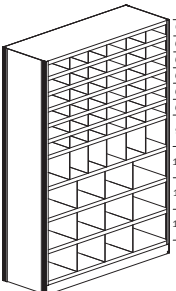
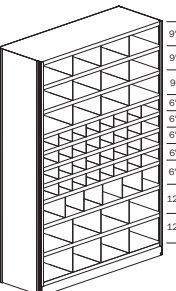

Bin Units 85" High with Series 2000 Shelves										
W	D	Capacity	Starter	Adder	Starter	Adder	Starter	Adder	Starter	Adder
36"	12"	800#	DP1825	DP1828	DP1215	DP1218	DP1227	DP1230	DP1831	DP1834
36"	18"	850#	DP1826	DP1829	DP1216	DP1219	DP1228	DP1231	DP1832	DP1835
36"	24"	800#	DP1827	DP1830	DP1217	DP1220	DP1229	DP1232	DP1833	DP1836
										
W	D	Capacity	Starter	Adder	Starter	Adder	Starter	Adder	Starter	Adder
48"	12"	500#	DP1837	DP1840	DP1843	DP1846	DP1849	DP1852	DP1855	DP1858
48"	18"	550#	DP1838	DP1841	DP1844	DP1847	DP1850	DP1853	DP1856	DP1859
48"	24"	550#	DP1839	DP1842	DP1845	DP1848	DP1851	DP1854	DP1857	DP1860
										
W	D	Capacity	Starter	Adder	Starter	Adder	Starter	Adder	Starter	Adder
48"	12"	500#	DP1861	DP1864	DP1867	DP1870	DP1873	DP1876	DP1879	DP1882
48"	18"	550#	DP1862	DP1865	DP1868	DP1871	DP1874	DP1877	DP1880	DP1883
48"	24"	550#	DP1863	DP1866	DP1869	DP1872	DP1875	DP1878	DP1881	DP1884

Foot plates, available separately, are recommended for use on all shelving units to spread loads, prevent damage to floor surfaces, aid in shimming uprights to a plumb condition and allow for anchoring when necessary.

Industrial Clip Shelving



Plastic bin units provide economical, high-density storage of small parts and loose materials. Formed from high-density injection molded-plastic, bins won't rust or corrode. A special reinforced design adds strength and prevents spreading, allowing bins to be stacked.

Clear front windows may be added to maximize capacity, prevent spilling and convert the bin to a tote. Optional dividers keep stored materials organized within the bin.

Open units feature angle posts, side and back sway bracing and 20 ga. open flange shelves (36"x12" & 36"x18") or 22

ga. Series 2000 shelves (42"x18").

Order one starter unit and the balance as adders to make up a row of shelving. Units are available from stock in #50 Gray and from production in #83 Decorator Tan. Shelving units are shipped K.D. (knocked down) from all Republic locations. Bins are shipped separately. Contact Canton for details.



#50 Gray



#83 Decorator Tan

Plastic Bin Units 85" High with 20 Gauge Open Flange Shelves and Bins		8 Shelves 28 Bins $\frac{W}{8\frac{1}{4}} \quad \frac{H}{7} \quad \frac{L}{14\frac{3}{4}}$		10 Shelves 12 Bins $\frac{W}{8\frac{1}{4}} \quad \frac{H}{7} \quad \frac{L}{14\frac{3}{4}}$ 36 Bins $\frac{W}{5\frac{1}{2}} \quad \frac{H}{5} \quad \frac{L}{11}$		8 Shelves 14 Bins $\frac{W}{16\frac{1}{2}} \quad \frac{H}{7} \quad \frac{L}{17\frac{3}{4}}$																	
	<table border="1"> <thead> <tr> <th>W</th> <th>D</th> <th>Capacity</th> <th>Starter</th> <th>Adder</th> <th>Starter</th> <th>Adder</th> <th>Starter</th> <th>Adder</th> </tr> </thead> <tbody> <tr> <td>36"</td> <td>12"</td> <td>390#</td> <td>DP1795</td> <td>DP1796</td> <td>DP1797</td> <td>DP1798</td> <td>DP1799</td> <td>DP1800</td> </tr> </tbody> </table>	W	D	Capacity	Starter	Adder	Starter	Adder	Starter	Adder	36"	12"	390#	DP1795	DP1796	DP1797	DP1798	DP1799	DP1800				
W	D	Capacity	Starter	Adder	Starter	Adder	Starter	Adder															
36"	12"	390#	DP1795	DP1796	DP1797	DP1798	DP1799	DP1800															
Plastic Bin Units 85" High with 20 Gauge Open Flange Shelves and Bins		8 Shelves 21 Bins $\frac{W}{11} \quad \frac{H}{8} \quad \frac{L}{16}$		7 Shelves 24 Bins $\frac{W}{8\frac{1}{4}} \quad \frac{H}{9} \quad \frac{L}{18}$		6 Shelves 10 Bins $\frac{W}{16\frac{1}{4}} \quad \frac{H}{11} \quad \frac{L}{18}$																	
	<table border="1"> <thead> <tr> <th>W</th> <th>D</th> <th>Capacity</th> <th>Starter</th> <th>Adder</th> <th>Starter</th> <th>Adder</th> <th>Starter</th> <th>Adder</th> </tr> </thead> <tbody> <tr> <td>36"</td> <td>18"</td> <td>410#</td> <td>DP1801</td> <td>DP1802</td> <td>DP1803</td> <td>DP1804</td> <td>DP1805</td> <td>DP1806</td> </tr> </tbody> </table>	W	D	Capacity	Starter	Adder	Starter	Adder	Starter	Adder	36"	18"	410#	DP1801	DP1802	DP1803	DP1804	DP1805	DP1806				
W	D	Capacity	Starter	Adder	Starter	Adder	Starter	Adder															
36"	18"	410#	DP1801	DP1802	DP1803	DP1804	DP1805	DP1806															
Plastic Bin Units 85" High with 22 Gauge Series 2000 Shelves and Bins		6 Shelves 10 Bins $\frac{W}{18\frac{3}{8}} \quad \frac{H}{11\frac{7}{8}} \quad \frac{L}{19\frac{3}{4}}$		7 Shelves 3 Bins $\frac{W}{12\frac{3}{8}} \quad \frac{H}{5\frac{7}{8}} \quad \frac{L}{19\frac{3}{4}}$ 6 Bins $\frac{W}{12\frac{3}{8}} \quad \frac{H}{7\frac{7}{8}} \quad \frac{L}{19\frac{3}{4}}$ 3 Bins $\frac{W}{12\frac{3}{8}} \quad \frac{H}{11\frac{7}{8}} \quad \frac{L}{19\frac{3}{4}}$ 4 Bins $\frac{W}{18\frac{3}{8}} \quad \frac{H}{11\frac{7}{8}} \quad \frac{L}{19\frac{3}{4}}$		6 Shelves 15 Bins $\frac{W}{12\frac{3}{8}} \quad \frac{H}{11\frac{7}{8}} \quad \frac{L}{19\frac{3}{4}}$																	
	<table border="1"> <thead> <tr> <th>W</th> <th>D</th> <th>Capacity</th> <th>Starter</th> <th>Adder</th> <th>Starter</th> <th>Adder</th> <th>Starter</th> <th>Adder</th> </tr> </thead> <tbody> <tr> <td>42"</td> <td>18"</td> <td>335#</td> <td>DP1807</td> <td>DP1808</td> <td>DP1809</td> <td>DP1810</td> <td>DP1811</td> <td>DP1812</td> </tr> </tbody> </table>	W	D	Capacity	Starter	Adder	Starter	Adder	Starter	Adder	42"	18"	335#	DP1807	DP1808	DP1809	DP1810	DP1811	DP1812				
W	D	Capacity	Starter	Adder	Starter	Adder	Starter	Adder															
42"	18"	335#	DP1807	DP1808	DP1809	DP1810	DP1811	DP1812															

Industrial Clip Shelving

Accessories

Republic offers a full line of accessories to customize clip shelving units. Stock components are shown in bold.

Shelf dividers create individual storage areas on a shelf. Full height dividers attach to shelves to create bins in the shelving unit. Made from 22 gauge steel, they are formed with beaded ends for clear access to shelf space. Top and bottom flanges are punched with holes to attach to shelf using push-in plastic clips.

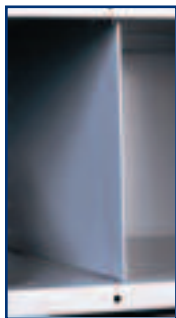

Full Height Dividers		
D	H	Part Number
12"	6"	106521
12"	7 1/2"	106522
12"	9"	106523
12"	10 1/2"	106524
12"	12"	106525
12"	13 1/2"	106526
12"	15"	106527
12"	16 1/2"	106528
12"	18"	106529
15"	6"	106532
15"	7 1/2"	106533
15"	9"	106534
15"	10 1/2"	106535
15"	12"	106536
15"	13 1/2"	106537
15"	15"	106538
15"	16 1/2"	106539
15"	18"	106540
18"	6"	106543
18"	7 1/2"	106544
18"	9"	106545
18"	10 1/2"	106546
18"	12"	106547
18"	13 1/2"	106548
18"	15"	106549
18"	16 1/2"	106550
18"	18"	106551
24"	6"	106554
24"	7 1/2"	106555
24"	9"	106556
24"	10 1/2"	106557
24"	12"	106558
24"	13 1/2"	106559
24"	15"	106560
24"	16 1/2"	106561
24"	18"	106562



Angle and sliding dividers are made from 22 gauge and are used to partition surfaces. Angle dividers (left)

have a 3/4" return flange on the bottom that allow them to be bolted to shelf surfaces. Sliding dividers (right) are easily repositioned to handle changing needs. A 3" x 1 3/8" tabbed label holder is formed into the front face of the divider for contents identification.



Heavy duty sliding dividers of 18 gauge steel may be used for more rugged storage applications.

Angle Dividers		
D	H	Part Number
12"	2"	106672
12"	3"	106673
12"	4"	106674
18"	2"	106680
18"	3"	106681
18"	4"	106682
Sliding Dividers with Label Holders		
D	H	Part Number
12"	4"	100885
12"	6"	100900
18"	4"	100886
18"	6"	100901
Heavy Duty Sliding Dividers		
D	H	Part Number
12"	6"	106905
15"	6"	106906
18"	6"	106907

Label holders run the full width of the shelf and accept inserts for content identification.



Label Holders		
W	H	Part Number
36"	7/8"	103716
42"	7/8"	103717
48"	7/8"	103718



Shelf boxes 4 5/8" high offer storage for small or loose parts. A 6" vertical shelf spacing is required. Box dividers create individual compartments within the shelf box. Two box guides per shelf are required for proper alignment (order separately).

Shelf Boxes		
W	D	Part Number
4 1/8"	11 5/8"	109000
4 1/8"	17 5/8"	109004
4 1/8"	23 5/8"	109008
5 1/2"	11 5/8"	109001
5 1/2"	17 5/8"	109005
5 1/2"	23 5/8"	109009
8 3/8"	11 5/8"	109002
8 3/8"	17 5/8"	109006
8 3/8"	23 5/8"	109010
11 1/8"	11 5/8"	109003
11 1/8"	17 5/8"	109007
11 1/8"	23 5/8"	109011
Shelf Box Dividers		
W	H	Part Number
4 1/8"	4 5/8"	109100
5 1/2"	4 5/8"	109101
8 3/8"	4 5/8"	109102
11 1/8"	4 5/8"	109103
Box Guides		
D	H	Part Number
12"	1 3/8"	106690
18"	1 3/8"	106692
24"	1 3/8"	106693

Bin Fronts of 18 gauge steel keep small parts and packages on the shelf. The top and bottom are flanged so the bin front may be used as a card holder.

Bin Fronts		
W	H	Part Number
36"	1 1/2"	109801
42"	1 1/2"	109802
48"	1 1/2"	109803
36"	3"	109805
42"	3"	109806
48"	3"	109807
36"	4 1/2"	109812
42"	4 1/2"	109813
48"	4 1/2"	109814
36"	6"	109817
42"	6"	109818
48"	6"	109819



#50 Gray



#83 Decorator Tan

Where shown in bold, parts are available from stock in #50 Gray. Items are available from production in #50 Gray and #83 Decorator Tan.

Industrial Clip Shelving

Accessories

Designed to fit 36" wide clip shelving units, **Maxi-Stor Modular Drawers** are available in 18" and 24" depths and provide secure storage for valuable parts, tools and other items.

Modular drawer systems consist of support frames and drawers with a combination of partitions and dividers. When selecting drawers, the combined height of drawers must equal the frame height. Partitions and dividers separate drawers into the number and size of compartments needed. Partitions have adjustment slots on 1" centers.

Drawers are made from heavy gauge, furniture quality steel and feature durable drawer pulls with vinyl protected labels. Sturdy frames with ball bearing suspension allow drawers to open and close smoothly.

Modular Drawers for 36" W Units		
D	H	Part Number
18"	3"	9329590
18"	4"	9329592
18"	5"	9329594
18"	6"	9329596
18"	7"	9329598
24"	3"	9329591
24"	4"	9329593
24"	5"	9329595
24"	6"	9329597
24"	7"	9329599

Hardware included. Dimensions shown are nominal outside dimensions. Actual drawer face height is 5/16" less than nominal. Usable inside drawer height is 1 1/8" less than nominal height shown. Actual drawer body heights vary from 1 3/16" to 2 1/2" less than nominal height.

Front and Rear Support Frames		
W	H	Part Number
36"	6"	9329586
36"	18"	9329588
36"	36"	9329589

Drawer Partitions (front to back)		
D	H	Part Number
18"	3"	9329681
18"	4"	9329683
18"	5"	9329685
18"	6", 7"	9329687
24"	3"	9329682
24"	4"	9329684
24"	5"	9329686
24"	6", 7"	9329688

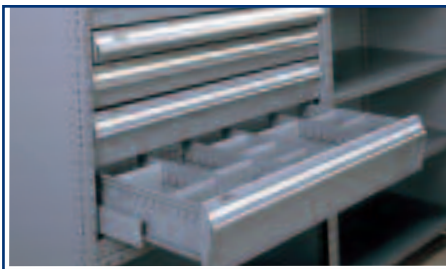

Drawer Dividers (side to side)		
W	H (drawer)	Part Number
3"	3"	9329699
4"	3"	9329700
5"	3"	9329701
6"	3"	9329702
8"	3"	9329703
3"	4"	9329707
4"	4"	9329708
5"	4"	9329709
6"	4"	9329710
8"	4"	9329711
4"	5"	9329715
5"	5"	9329716
6"	5"	9329717
8"	5"	9329718
4"	6", 7"	9329722
5"	6", 7"	9329723
6"	6", 7"	9329724
8"	6", 7"	9329725
10"	6", 7"	9329727
12"	6", 7"	9329728

Drawer Insert Units provide economical small parts storage in 36" wide clip shelving units. Insert units are 34 3/4" wide 10 3/4" high. Drawers are punched to accept labels. Extra dividers in drawers create additional compartments.



Drawer Insert Units		
	D	Part Number
24 Drawer	12"	176291
24 Drawer	18"	176292
Extra Divider		1710140
18 Drawer	12"	176295
18 Drawer	18"	176293
Extra Divider		1710141
12 Drawer	18"	176294
Extra Divider		1710142

Plastic Bins are an economical option for high density storage of small or loose parts. Formed from injection-molded plastic, bins are rust and corrosion proof. Clear front windows may be added to maximize capacity, prevent spills and convert the bin to a tote. Optional dividers keep stored materials organized.



Plastic Bins				
Color	W	H	L	Part Number
Blue	8 1/4"	7"	14 3/4"	109110
Blue	5 1/2"	5"	11"	109111
Yellow	16 1/2"	7"	14 3/4"	109112
Blue	11"	8"	16"	109113
Yellow	8 1/4"	9"	18"	109114
Blue	16 1/2"	11"	18"	109115
Red	18 3/8"	11 7/8"	19 3/4"	109116
Blue	12 3/8"	11 7/8"	19 3/4"	109117
Yellow	12 3/8"	7 7/8"	19 3/4"	109118
Blue	12 3/8"	5 7/8"	19 3/4"	109119

Plastic Bins		
Plastic Bin	Window #	Divider #
For # 109110	109120	109130
For # 109111	109121	109131
For # 109112	109122	109132
For # 109113	109123	109133
For # 109114	109124	109134
For # 109115	109125	109135
For # 109116	109126	109136
For # 109117	109127	109137
For # 109118	109128	109138
For # 109119	109129	109139

Industrial Clip Shelving

Components

Stock components shown in bold.

Angle Post

3'1" high	100017
3'4" high	100019
4'1" high	100025
5'1" high	100033
6'1" high	100041
7'1" high	100049
8'1" high	100057
9'1" high	100065
10'1" high	100073
11'1" high	100081
12'1" high	100089
13'1" high	100090
14'1" high	100091
15'1" high	100092
16'1" high	100093
Splice	199220

Beaded Post

3'1" high	107017
3'4" high	107019
4'1" high	107025
5'1" high	107033
6'1" high	107041
7'1" high	107049
8'1" high	107057
9'1" high	107065
10'1" high	107073
11'1" high	107081
12'1" high	107089
13'1" high	107090
14'1" high	107091
15'1" high	107092
16'1" high	107093
Splice	199219

Heavy Duty Post

7'1" high	121768
8'1" high	121776
9'1" high	121784
10'1" high	121792
11'1" high	121800
12'1" high	121808
13'1" high	121816
14'1" high	121824
15'1" high	121832
16'1" high	121840
Splice	191610

Foot Plate - Angle/Beaded Post

2-1/8" x 2-7/8"	193701
-----------------	---------------

Foot Plate - Heavy Duty Post

2-1/8" x 2-7/8"	191615
-----------------	--------

Sway Braces for Units

9", 15"D	106821
12", 24"D, 24"W	106822
18", 24"D, 30"W	106823
32"D	106820

30", 36"D, 36"W	106824
42", 48"W	106825
54"W	106826
60"W	106827

Heavy Duty Side Sway Braces for Units

18"D	124991
24"D	124992
30"D	124993
36"D	124994

Heavy Duty Back Sway Braces for Units

36"W	124995
42, 48"W	124996

Angle Sway Braces

For Angle Posts	193700
For Beaded Posts	196866

Back

24" wide x 5'1" high	105033
24" wide x 6'1" high	105041
24" wide x 7'1" high	105049
24" wide x 8'1" high	105057
30" wide x 5'1" high	105106
30" wide x 6'1" high	105114
30" wide x 7'1" high	105122
30" wide x 8'1" high	105130
36" wide x 3'1" high	105163
36" wide x 3'4" high	105165
36" wide x 4'1" high	105171
36" wide x 5'1" high	105179
36" wide x 6'1" high	105187
36" wide x 7'1" high	105195
36" wide x 8'1" high	105203
42" wide x 3'1" high	105236
42" wide x 3'4" high	105238
42" wide x 4'1" high	105244
42" wide x 5'1" high	105252
42" wide x 6'1" high	105260
42" wide x 7'1" high	105268
48" wide x 3'1" high	105309
48" wide x 3'4" high	105311
48" wide x 4'1" high	105317
48" wide x 5'1" high	105325
48" wide x 6'1" high	105333
48" wide x 7'1" high	105341
54" wide x 3'1" high	105366
54" wide x 3'4" high	105368
54" wide x 4'1" high	105374
54" wide x 5'1" high	105382
60" wide x 3'1" high	105423
60" wide x 3'4" high	105425
60" wide x 4'1" high	105431
60" wide x 5'1" high	105439
24" wide splice	109210
30" wide splice	109211
36" wide splice	109212
42" wide splice	109213
48" wide splice	109214
54" wide splice	109215
60" wide splice	109216

Side Sheet

12" deep x 3'1" high	101090
12" deep x 3'4" high	101092
12" deep x 4'1" high	101098
12" deep x 5'1" high	101106
12" deep x 6'1" high	101114
12" deep x 7'1" high	101122
12" deep x 8'1" high	101130
15" deep x 3'1" high	101163
15" deep x 3'4" high	101165
15" deep x 4'1" high	101171
15" deep x 5'1" high	101179
15" deep x 6'1" high	101187
15" deep x 7'1" high	101195
15" deep x 8'1" high	101203
18" deep x 3'1" high	101236
18" deep x 3'4" high	101238
18" deep x 4'1" high	101244
18" deep x 5'1" high	101252
18" deep x 6'1" high	101260
18" deep x 7'1" high	101268
18" deep x 8'1" high	101276
24" deep x 3'1" high	101309
24" deep x 3'4" high	101311
24" deep x 4'1" high	101317
24" deep x 5'1" high	101325
24" deep x 6'1" high	101333
24" deep x 7'1" high	101341
24" deep x 8'1" high	101349
30" deep x 6'1" high	101406
30" deep x 7'1" high	101414
30" deep x 8'1" high	101422
32" deep x 7'1" high	101512
32" deep x 8'1" high	101513
36" deep x 6'1" high	101479
36" deep x 7'1" high	101487
36" deep x 8'1" high	101495
12" deep splice	109201
15" deep splice	109202
18" deep splice	109203
24" deep splice	109204
30" deep splice	109205
32" deep splice	109208
36" deep splice	109206

Welded End Upright Assembly (Angle Post)

12" deep x 3'4" high	103092
12" deep x 4'1" high	103098
12" deep x 5'1" high	103106
12" deep x 6'1" high	103114
12" deep x 7'1" high	103122
12" deep x 8'1" high	103130
15" deep x 7'1" high	103195
18" deep x 3'4" high	103238
18" deep x 4'1" high	103244
18" deep x 5'1" high	103252
18" deep x 6'1" high	103260
18" deep x 7'1" high	103268
18" deep x 8'1" high	103276
18" deep x 9'1" high	103284
18" deep x 10'1" high	103292

24" deep x 3'4" high	103311
24" deep x 4'1" high	103317
24" deep x 5'1" high	103325
24" deep x 6'1" high	103333
24" deep x 7'1" high	103341
24" deep x 8'1" high	103349
24" deep x 9'1" high	103357
24" deep x 10'1" high	103365
30" deep x 7'1" high	103414
36" deep x 7'1" high	103487

Welded Intermediate Upright Assembly (Angle Post)

12" deep x 3'4" high	104092
12" deep x 4'1" high	104098
12" deep x 5'1" high	104106
12" deep x 6'1" high	104114
12" deep x 7'1" high	104122
12" deep x 8'1" high	104130
15" deep x 7'1" high	104195
18" deep x 3'4" high	104238
18" deep x 4'1" high	104244
18" deep x 5'1" high	104252
18" deep x 6'1" high	104260
18" deep x 7'1" high	104268
18" deep x 8'1" high	104276
18" deep x 9'1" high	104284
18" deep x 10'1" high	104292
24" deep x 3'4" high	104311
24" deep x 4'1" high	104317
24" deep x 5'1" high	104325
24" deep x 6'1" high	104333
24" deep x 7'1" high	104341
24" deep x 8'1" high	104349
24" deep x 9'1" high	104357
24" deep x 10'1" high	104365
30" deep x 7'1" high	104414
36" deep x 7'1" high	104487

Welded End Upright Assembly (Beaded Post)

12" deep x 7'1" high	107322
15" deep x 7'1" high	107395
15" deep x 8'1" high	107403
18" deep x 6'1" high	107460
18" deep x 7'1" high	107468
18" deep x 8'1" high	107476
24" deep x 7'1" high	107541
24" deep x 8'1" high	107549
30" deep x 7'1" high	107614
36" deep x 7'1" high	107687

Welded Intermediate Upright Assembly (Beaded Post)

12" deep x 7'1" high	108322
15" deep x 7'1" high	108395
15" deep x 8'1" high	108403
18" deep x 6'1" high	108460
18" deep x 7'1" high	108468
18" deep x 8'1" high	108476
24" deep x 7'1" high	108541
24" deep x 8'1" high	108549
30" deep x 7'1" high	108614
36" deep x 7'1" high	108687

Industrial Clip Shelving

Components

Stock components shown in bold.

Series 2000 18 ga. Shelves

36" wide x 12" deep	102207
36" wide x 15" deep	102212
36" wide x 18" deep	102217
36" wide x 24" deep	102222
36" wide x 30" deep	102227
36" wide x 36" deep	102234
42" wide x 12" deep	102208
42" wide x 15" deep	102213
42" wide x 18" deep	102218
42" wide x 24" deep	102223
42" wide x 30" deep	102228
42" wide x 32" deep	102230
42" wide x 36" deep	102235
48" wide x 12" deep	102209
48" wide x 15" deep	102214
48" wide x 18" deep	102219
48" wide x 24" deep	102224
48" wide x 30" deep	102229
48" wide x 36" deep	102236
54" wide x 18" deep	102243
54" wide x 24" deep	102245
54" wide x 30" deep	102247
54" wide x 32" deep	102249
54" wide x 36" deep	102250
60" wide x 18" deep	102244
60" wide x 24" deep	102246
60" wide x 30" deep	102248
60" wide x 36" deep	102251

Series 2000 20 ga. Shelves

24" wide x 12" deep	102105
24" wide x 18" deep	102115
24" wide x 24" deep	102120
30" wide x 12" deep	102106
30" wide x 18" deep	102116
30" wide x 24" deep	102121
36" wide x 12" deep	102107
36" wide x 15" deep	102112
36" wide x 18" deep	102117
36" wide x 24" deep	102122
36" wide x 30" deep	102127
36" wide x 36" deep	102134
42" wide x 12" deep	102108
42" wide x 15" deep	102113
42" wide x 18" deep	102118
42" wide x 24" deep	102123
42" wide x 30" deep	102128
42" wide x 32" deep	102130
42" wide x 36" deep	102135
48" wide x 12" deep	102109
48" wide x 15" deep	102114
48" wide x 18" deep	102119
48" wide x 24" deep	102124
48" wide x 30" deep	102129
48" wide x 36" deep	102136

54" wide x 18" deep	102143
54" wide x 24" deep	102145
54" wide x 30" deep	102147
54" wide x 32" deep	102149
54" wide x 36" deep	102150
60" wide x 18" deep	102144
60" wide x 24" deep	102146
60" wide x 30" deep	102148
60" wide x 36" deep	102151

Series 2000 22 ga. Shelves

24" wide x 12" deep	102005
24" wide x 18" deep	102015
24" wide x 24" deep	102020
30" wide x 12" deep	102006
30" wide x 18" deep	102016
30" wide x 24" deep	102021
36" wide x 12" deep	102007
36" wide x 15" deep	102012
36" wide x 18" deep	102017
36" wide x 24" deep	102022
36" wide x 30" deep	102027
36" wide x 36" deep	102034
42" wide x 12" deep	102008
42" wide x 15" deep	102013
42" wide x 18" deep	102018
42" wide x 24" deep	102023
42" wide x 30" deep	102028
42" wide x 32" deep	102030
42" wide x 36" deep	102035
48" wide x 12" deep	102009
48" wide x 15" deep	102014
48" wide x 18" deep	102019
48" wide x 24" deep	102024
48" wide x 30" deep	102029
48" wide x 36" deep	102036

Open Flange 20 ga. Shelves

36" wide x 12" deep	112512
36" wide x 18" deep	112513
36" wide x 24" deep	112514
48" wide x 12" deep	112518

Open Flange 18 ga. Shelves

36" wide x 9" deep	106003
36" wide x 12" deep	106008
36" wide x 15" deep	106013
36" wide x 18" deep	106018
36" wide x 24" deep	106023
36" wide x 30" deep	106028
36" wide x 36" deep	106033
42" wide x 12" deep	106009
42" wide x 15" deep	106014
42" wide x 18" deep	106019
42" wide x 24" deep	106024
42" wide x 30" deep	106029
42" wide x 32" deep	106040
42" wide x 36" deep	106034
48" wide x 12" deep	106010
48" wide x 15" deep	106015
48" wide x 18" deep	106020
48" wide x 24" deep	106025

48" wide x 30" deep	106030
48" wide x 30" deep	106035

Front Base (for Angle Post)

24" wide x 1 1/2" high	107970
30" wide x 1 1/2" high	107971
36" wide x 1 1/2" high	107972
42" wide x 1 1/2" high	107973
48" wide x 1 1/2" high	107974
54" wide x 1 1/2" high	108010
60" wide x 1 1/2" high	108011
24" wide x 3" high	107976
30" wide x 3" high	107977
36" wide x 3" high	107978
42" wide x 3" high	107979
48" wide x 3" high	107980
54" wide x 3" high	108012
60" wide x 3" high	108013

Front Base (for Beaded Post)

24" wide x 1 1/2" high	107990
30" wide x 1 1/2" high	107991
36" wide x 1 1/2" high	107992

42" wide x 1 1/2" high	107993
48" wide x 1 1/2" high	107994
54" wide x 1 1/2" high	108020
60" wide x 1 1/2" high	108021
24" wide x 3" high	107996
30" wide x 3" high	107997
36" wide x 3" high	107998
42" wide x 3" high	107999
48" wide x 3" high	108000
54" wide x 3" high	108022
60" wide x 3" high	108023

End Base

12" deep x 3" high	106712
15" deep x 3" high	106713
18" deep x 3" high	106714
24" deep x 3" high	106715
30" deep x 3" high	106716
36" deep x 3" high	106717

Clips (supplied with shelves)

Shelf Clip	193719
Half Shelf Clip	193728



Automotive Shelving



Republic's **Automotive Shelving** is specifically designed for automotive service centers, dealerships and auto parts stores. 84" high units are designed with shelves that slide into slots on the unit uprights, allowing for easy reconfiguration of units. Shelves are adjustable on 1 1/2" centers and have a full return flange on the front for added strength.

An assortment of sliding dividers and shelf boxes can be added to units for custom storage solutions. Bases and label holders for material identification complete the unit.

Each unit requires two uprights. Units are available from stock in color #50 Gray with #50 Gray or #93 White Mist backs. Units in color #83 Decorator Tan are available from production.

Units are shipped K.D. (knocked down) from Republic's Canton, OH location.

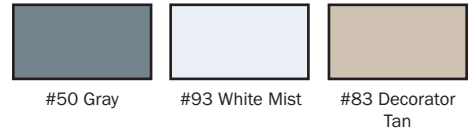

Components & Accessories
(stock part numbers in **bold**)

Upright	12" deep x 84" high	1510278
Back	37 1/2" wide x 84" high	1510313
Sliding Shelf	35 7/8" wide x 12" deep	1510281
Base	35" wide x 3" high	1510305



Full Length Label Holder	35 5/8" wide x 7/8" high	1510373
Magnetic Label Holder (pk of 100)	3" wide x 1" high	704317
Connecting Bolts (pk of 100)	Used to tie units	704340



Sliding Divider	12" deep x 3" high	1510370
	12" deep x 4 1/2" high	1510371
	12" deep x 6" high	1510372



Shelf Box (order dividers separately)	5 11/16" w x 11 3/4" d x 3 5/16" h	1510298
Shelf Box Divider	5 1/2" wide x 3 1/4" high	1510302

Automotive Units

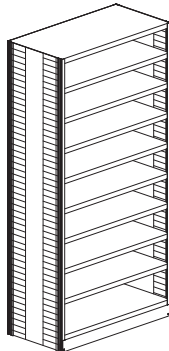

Basic 10 Shelf Unit

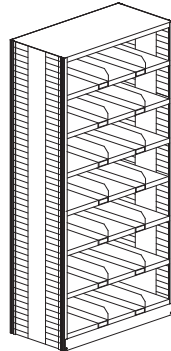

21 Opening Unit
18-12"x12", 3-12"x9"

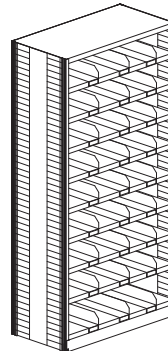

36 Opening Unit
36-9"x9"

W	D	H	Part #	Part #	Part #
36"	12"	84"	DP1501	DP1504	DP1505

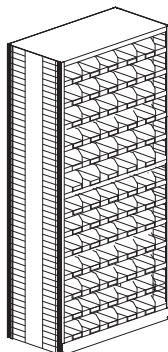

78 Opening Unit
6-6"x9", 72-6"x6"

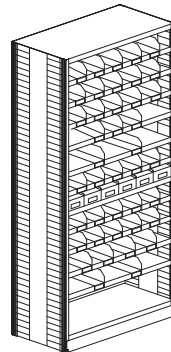

52 Opening Combo Unit

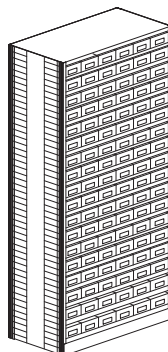

108 Opening Box Unit

W	D	H	Part #	Part #	Part #
36"	12"	84"	DP1506	DP1507	DP1508

Rivet Wedge-Lock

Components

Wedge-Lock Shelf Framing

Systems provide economical and versatile storage solutions for a variety of applications including retail stock rooms, auto parts centers and archive storerooms. The shelving units consist of primary framing members that snap together for easy assembly without bolts, clips or other fasteners.



Rivet Connection

Shelves are accessible from all four sides because no cross-bracing is required. A rivet-type stud on the beam engages a teardrop hole on the post to form a solid connection. A mallet strike secures the frame. Deck material completes the unit.



Heavy Angle Post T-Post Heavy T-Post

■ Heavy Angle Post

- 14 gauge angle formation
- teardrop holes punched for 1 1/2" vertical shelf adjustment
- used at aisle ends on all units
- heights to 16'

■ T-Post

- 14 gauge T-formation
- teardrop holes punched for 1 1/2" vertical shelf adjustment
- used at intermediate positions on standard, bulk and archive units
- heights to 10'

■ Heavy T-Post

- 14 gauge T-formation
- teardrop holes punched for 1 1/2" vertical shelf adjustment
- used at intermediate positions on high-capacity bulk units
- heights to 16'

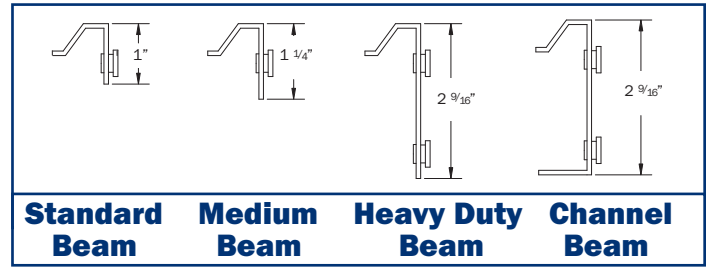

■ Standard Beam

- 14 ga. - 1" tall to support 1/2" or 5/8" particle board or plywood
- used at intermediate shelf locations front and back of standard units
- widths to 4'; single rivet construction

■ Medium Beam

- 14 ga. - 1 1/4" tall to support 3/4" or 7/8" particle board or plywood
- used at intermediate shelf locations front and back of standard units with thicker deck material
- widths to 4'; single rivet construction

■ Heavy Duty Beam

- 14 gauge - 2 9/16" tall
- used top, bottom full perimeter and front-to-back intermediate on standard units
- used full perimeter at all levels on bulk units
- used front-to-back at all levels on high-capacity bulk units
- widths to 8'; double rivet construction for improved stability

■ Channel Beam

- 14 gauge - 2 9/16" tall with 7/8" return flange on bottom of beam
- used side-to-side at all levels on high-capacity bulk units
- widths to 8'; double rivet construction for improved stability

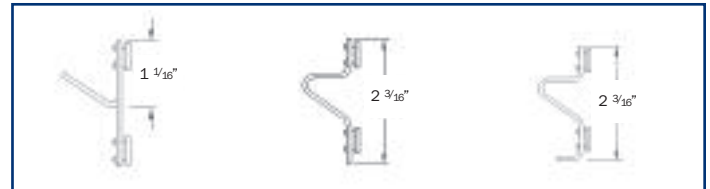

■ Low Profile Beam

- 14 gauge - 1 1/16" high
- used when more clear shelf height is needed in standard units
- widths to 4'; double rivet construction for improved stability

■ Z-Beam

- 14 gauge - 2 3/16" high
- offers high-capacity storage with greater clear shelf height in standard and bulk units
- widths to 5'; double rivet construction for improved stability

■ Heavy Z-Beam

- 14 gauge - 2 3/16" with 1/2" return flange on bottom of beam
- offers high-capacity storage with greater clear shelf height in high-capacity bulk units
- widths from 4' to 6'; double rivet construction for improved stability

Rivet Wedge-Lock



Standard units provide sturdy, basic storage at an affordable price. A variety of sizes, capacities and shelf levels offer versatile storage in commercial or industrial applications.

The units shown below feature 14 gauge angle and T-posts. Heavy duty beams are used full perimeter at the top and bottom of the unit for stability; standard beams are used side-to-side at intermediate shelf levels. Units are available with framing only, with $\frac{5}{8}$ " particle board deck or with wire deck.

Order one starter unit and the balance as adders to make up a row of shelving. Units are available from stock in color #50 Gray and from production in color #83 Decorator Tan.

Units ship K.D. (knocked down) from any Republic location.

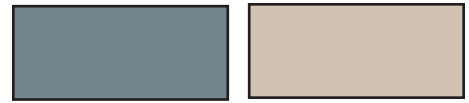

#50 Gray

#83 Decorator Tan

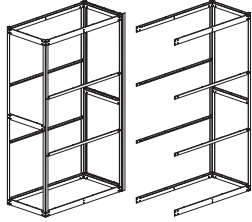
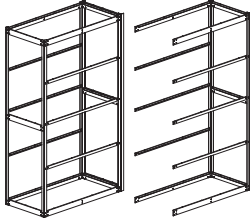
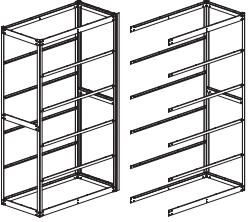
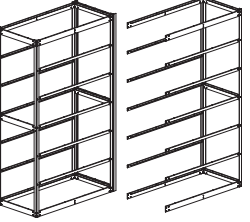

Standard Units										
84" H - no deck			4 Shelves		5 Shelves		6 Shelves		7 Shelves	
W	D	Shelf Cap.	Starter	Adder	Starter	Adder	Starter	Adder	Starter	Adder
36"	12"	425#	DP2700	DP2701	DP2712	DP2713	DP2724	DP2725	DP2736	DP2737
36"	18"	400#	DP2702	DP2703	DP2714	DP2715	DP2726	DP2727	DP2738	DP2739
36"	24"	305#	DP2704	DP2705	DP2716	DP2717	DP2728	DP2729	DP2740	DP2741
48"	12"	310#	DP2706	DP2707	DP2718	DP2719	DP2730	DP2731	DP2742	DP2743
48"	18"	310#	DP2708	DP2709	DP2720	DP2721	DP2732	DP2733	DP2744	DP2745
48"	24"	310#	DP2710	DP2711	DP2722	DP2723	DP2734	DP2735	DP2746	DP2747
84" H - board deck			4 Shelves		5 Shelves		6 Shelves		7 Shelves	
W	D	Capacity	Starter	Adder	Starter	Adder	Starter	Adder	Starter	Adder
36"	12"	425#	DP2700B	DP2701B	DP2712B	DP2713B	DP2724B	DP2725B	DP2736B	DP2737B
36"	18"	400#	DP2702B	DP2703B	DP2714B	DP2715B	DP2726B	DP2727B	DP2738B	DP2739B
36"	24"	305#	DP2704B	DP2705B	DP2716B	DP2717B	DP2728B	DP2729B	DP2740B	DP2741B
48"	12"	310#	DP2706B	DP2707B	DP2718B	DP2719B	DP2730B	DP2731B	DP2742B	DP2743B
48"	18"	310#	DP2708B	DP2709B	DP2720B	DP2721B	DP2732B	DP2733B	DP2744B	DP2745B
48"	24"	310#	DP2710B	DP2711B	DP2722B	DP2723B	DP2734B	DP2735B	DP2746B	DP2747B
84" H - wire deck			4 Shelves		5 Shelves		6 Shelves		7 Shelves	
W	D	Capacity	Starter	Adder	Starter	Adder	Starter	Adder	Starter	Adder
36"	12"	425#	DP2700W	DP2701W	DP2712W	DP2713W	DP2724W	DP2725W	DP2736W	DP2737W
36"	18"	400#	DP2702W	DP2703W	DP2714W	DP2715W	DP2726W	DP2727W	DP2738W	DP2739W
36"	24"	305#	DP2704W	DP2705W	DP2716W	DP2717W	DP2728W	DP2729W	DP2740W	DP2741W
48"	12"	310#	DP2706W	DP2707W	DP2718W	DP2719W	DP2730W	DP2731W	DP2742W	DP2743W
48"	18"	310#	DP2708W	DP2709W	DP2720W	DP2721W	DP2732W	DP2733W	DP2744W	DP2745W
48"	24"	310#	DP2710W	DP2711W	DP2722W	DP2723W	DP2734W	DP2735W	DP2746W	DP2747W

Capacities are based on 1/2" APA C-D Plugged, Group 1, Exp. 1 plywood (with grain running in depth direction) or Type 1-M-1, 5/8" particle board.

Rivet Wedge-Lock

Rivet Wedge-Lock bulk units have a greater shelf area than standard units, making them ideal for storing large or odd-sized items. The wide range of shelf sizes and capacities combined with the option of adding extra shelves allows you to design the bulk shelving system that best meets your needs.

Bulk units use 14 gauge angle and T-posts. Heavy duty beams are used full perimeter at all levels. Beams are punched to accept front-to-rear shelf supports supplied on 36" and 48" deep

units. Bulk units are also available with Z-beams. Z-beams have a shorter profile and support the deck below the top of the beam for greater clear shelf height. Units are available with no deck, 5/8" particle board deck or wire deck.

Order one starter unit and the balance as adders to make up a row of shelving. Units are available from stock in color #50 Gray and from production in color #83 Decorator Tan. Units ship K.D. (knocked down) from any Republic location.

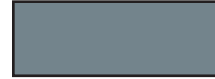

#50 Gray

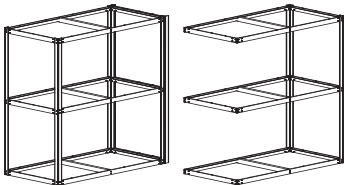
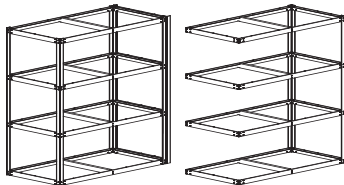

#83 Decorator Tan

Bulk Units 84" H							Extra shelf includes framing components necessary to add one shelf to an existing unit.
Heavy Beam - no deck			3 Shelves		4 Shelves		
W	D	Shelf Cap.	Starter	Adder	Starter	Adder	Starter
48"	18"	760#	DP2800	DP2801	DP2900	DP2901	DP2850
48"	24"	560#	DP2802	DP2803	DP2902	DP2903	DP2851
48"	36"	760#	DP2804	DP2805	DP2904	DP2905	DP2852
48"	48"	920#	DP2806	DP2807	DP2906	DP2907	DP2853
60"	18"	760#	DP2808	DP2809	DP2908	DP2909	DP2854
60"	24"	700#	DP2810	DP2811	DP2910	DP2911	DP2855
60"	36"	670#	DP2812	DP2813	DP2912	DP2913	DP2856
60"	48"	750#	DP2814	DP2815	DP2914	DP2915	DP2857
72"	18"	1,000#	DP2816	DP2817	DP2916	DP2917	DP2858
72"	24"	770#	DP2818	DP2819	DP2918	DP2919	DP2859
72"	36"	660#	DP2820	DP2821	DP2920	DP2921	DP2860
72"	48"	690#	DP2822	DP2823	DP2922	DP2923	DP2861
96"	18"	610#	DP2824	DP2825	DP2924	DP2925	DP2862
96"	24"	610#	DP2826	DP2827	DP2926	DP2927	DP2863
96"	36"	610#	DP2828	DP2829	DP2928	DP2929	DP2864
96"	48"	610#	DP2830	DP2831	DP2930	DP2931	DP2865
Heavy Beam - board deck			3 Shelves		4 Shelves		Extra Shelf
W	D	Shelf Cap.	Starter	Adder	Starter	Adder	Starter
48"	18"	760#	DP2800B	DP2801B	DP2900B	DP2901B	DP2850B
48"	24"	560#	DP2802B	DP2803B	DP2902B	DP2903B	DP2851B
48"	36"	760#	DP2804B	DP2805B	DP2904B	DP2905B	DP2852B
48"	48"	920#	DP2806B	DP2807B	DP2906B	DP2907B	DP2853B
60"	18"	760#	DP2808B	DP2809B	DP2908B	DP2909B	DP2854B
60"	24"	700#	DP2810B	DP2811B	DP2910B	DP2911B	DP2855B
60"	36"	670#	DP2812B	DP2813B	DP2912B	DP2913B	DP2856B
60"	48"	750#	DP2814B	DP2815B	DP2914B	DP2915B	DP2857B
72"	18"	1,000#	DP2816B	DP2817B	DP2916B	DP2917B	DP2858B
72"	24"	770#	DP2818B	DP2819B	DP2918B	DP2919B	DP2859B
72"	36"	660#	DP2820B	DP2821B	DP2920B	DP2921B	DP2860B
72"	48"	690#	DP2822B	DP2823B	DP2922B	DP2923B	DP2861B
96"	18"	610#	DP2824B	DP2825B	DP2924B	DP2925B	DP2862B
96"	24"	610#	DP2826B	DP2827B	DP2926B	DP2927B	DP2863B
96"	36"	610#	DP2828B	DP2829B	DP2928B	DP2929B	DP2864B
96"	48"	610#	DP2830B	DP2831B	DP2930B	DP2931B	DP2865B

Capacities are based on evenly distributed loads on one shelf when 5/8" Type 1-M-1 particle board is used as decking.

Rivet Wedge-Lock

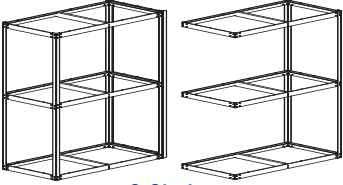
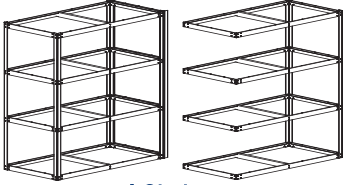
Bulk Units 84"H			 3 Shelves		 4 Shelves		Extra shelf includes framing components necessary to add one shelf to an existing unit. Extra Shelf
Heavy Beam - wire deck							
W	D	Shelf Cap.	Starter	Adder	Starter	Adder	Starter
48"	18"	760#	DP2800W	DP2801W	DP2900W	DP2901W	DP2850W
48"	24"	560#	DP2802W	DP2803W	DP2902W	DP2903W	DP2851W
48"	36"	760#	DP2804W	DP2805W	DP2904W	DP2905W	DP2852W
48"	48"	920#	DP2806W	DP2807W	DP2906W	DP2907W	DP2853W
60"	18"	760#	DP2808W	DP2809W	DP2908W	DP2909W	DP2854W
60"	24"	700#	DP2810W	DP2811W	DP2910W	DP2911W	DP2855W
60"	36"	670#	DP2812W	DP2813W	DP2912W	DP2913W	DP2856W
60"	48"	750#	DP2814W	DP2815W	DP2914W	DP2915W	DP2857W
72"	18"	1,000#	DP2816W	DP2817W	DP2916W	DP2917W	DP2858W
72"	24"	770#	DP2818W	DP2819W	DP2918W	DP2919W	DP2859W
72"	36"	660#	DP2820W	DP2821W	DP2920W	DP2921W	DP2860W
72"	48"	690#	DP2822W	DP2823W	DP2922W	DP2923W	DP2861W
96"	18"	610#	DP2824W	DP2825W	DP2924W	DP2925W	DP2862W
96"	24"	610#	DP2826W	DP2827W	DP2926W	DP2927W	DP2863W
96"	36"	610#	DP2828W	DP2829W	DP2928W	DP2929W	DP2864W
96"	48"	610#	DP2830W	DP2831W	DP2930W	DP2931W	DP2865W
Z-Beam - no deck			3 Shelves		4 Shelves		Extra Shelf
W	D	Shelf Cap.	Starter	Adder	Starter	Adder	Starter
48"	18"	760#	DP2870	DP2871	DP2970	DP2971	DP2932
48"	24"	560#	DP2872	DP2873	DP2972	DP2973	DP2933
48"	36"	760#	DP2874	DP2875	DP2974	DP2975	DP2934
48"	48"	920#	DP2876	DP2877	DP2976	DP2977	DP2935
60"	18"	760#	DP2878	DP2879	DP2978	DP2979	DP2936
60"	24"	700#	DP2880	DP2881	DP2980	DP2981	DP2937
60"	36"	670#	DP2882	DP2883	DP2982	DP2983	DP2938
60"	48"	750#	DP2884	DP2885	DP2984	DP2985	DP2939
Z-Beam - board deck			3 Shelves		4 Shelves		Extra Shelf
W	D	Shelf Cap.	Starter	Adder	Starter	Adder	Starter
48"	18"	760#	DP2870B	DP2871B	DP2970B	DP2971B	DP2932B
48"	24"	560#	DP2872B	DP2873B	DP2972B	DP2973B	DP2933B
48"	36"	760#	DP2874B	DP2875B	DP2974B	DP2975B	DP2934B
48"	48"	920#	DP2876B	DP2877B	DP2976B	DP2977B	DP2935B
60"	18"	760#	DP2878B	DP2879B	DP2978B	DP2979B	DP2936B
60"	24"	700#	DP2880B	DP2881B	DP2980B	DP2981B	DP2937B
60"	36"	670#	DP2882B	DP2883B	DP2982B	DP2983B	DP2938B
60"	48"	750#	DP2884B	DP2885B	DP2984B	DP2985B	DP2939B

Capacities are based on evenly distributed loads on one shelf when 5/8" Type 1-M-1 particle board is used as decking.

Rivet Wedge-Lock

When extra capacity is required, upgrade to **high capacity bulk units**. Shelves can carry up to double the load of regular bulk units. Extra shelves can be added for additional storage area.

High capacity bulk units use 14 gauge angle and heavy duty T-posts. Channel beams are used side-to-side. Beams are punched to accept front-to-rear shelf supports supplied on 36" and 48" deep units. Units are also available with heavy Z-beams that have a shorter profile and support the deck below the

top of the beam for greater clear shelf height. Units are available with no deck, 5/8" particle board deck or wire deck.

Order one starter unit and the balance as adders to make up a row of shelving. Units are available from stock in colors #50 Gray and from production in color #83 Decorator Tan. Units ship K.D. (knocked down) from any Republic location.

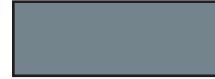

#50 Gray

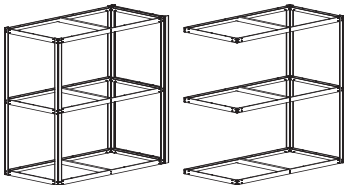
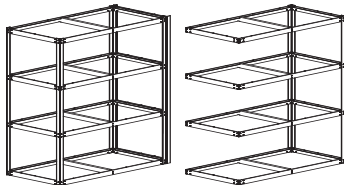

#83 Decorator Tan

High Capacity Bulk Units 84" H							Extra shelf includes framing components necessary to add one shelf to an existing unit.
Channel Beam - no deck			3 Shelves		4 Shelves		
W	D	Shelf Cap.	Starter	Adder	Starter	Adder	Starter
48"	18"	770#	DP2800H	DP2801H	DP2900H	DP2901H	DP2850H
48"	24"	700#	DP2802H	DP2803H	DP2902H	DP2903H	DP2851H
48"	36"	760#	DP2804H	DP2805H	DP2904H	DP2905H	DP2852H
48"	48"	920#	DP2806H	DP2807H	DP2906H	DP2907H	DP2853H
60"	18"	1,140#	DP2808H	DP2809H	DP2908H	DP2909H	DP2854H
60"	24"	1,180#	DP2810H	DP2811H	DP2910H	DP2911H	DP2855H
60"	36"	1,520#	DP2812H	DP2813H	DP2912H	DP2913H	DP2856H
60"	48"	1,680#	DP2814H	DP2815H	DP2914H	DP2915H	DP2857H
72"	18"	1,200#	DP2816H	DP2817H	DP2916H	DP2917H	DP2858H
72"	24"	1,140#	DP2818H	DP2819H	DP2918H	DP2919H	DP2859H
72"	36"	1,330#	DP2820H	DP2821H	DP2920H	DP2921H	DP2860H
72"	48"	1,670#	DP2822H	DP2823H	DP2922H	DP2923H	DP2861H
96"	18"	1,000#	DP2824H	DP2825H	DP2924H	DP2925H	DP2862H
96"	24"	1,000#	DP2826H	DP2827H	DP2926H	DP2927H	DP2863H
96"	36"	1,000#	DP2828H	DP2829H	DP2928H	DP2929H	DP2864H
96"	48"	1,000#	DP2830H	DP2831H	DP2930H	DP2931H	DP2865H
Channel Beam - Board Deck			3 Shelves		4 Shelves		Extra Shelf
W	D	Shelf Cap.	Starter	Adder	Starter	Adder	Starter
48"	18"	770#	D2800HB	D2801HB	D2900HB	D2901HB	D2850HB
48"	24"	700#	D2802HB	D2803HB	D2902HB	D2903HB	D2851HB
48"	36"	760#	D2804HB	D2805HB	D2904HB	D2905HB	D2852HB
48"	48"	920#	D2806HB	D2807HB	D2906HB	D2907HB	D2853HB
60"	18"	1,140#	D2808HB	D2809HB	D2908HB	D2909HB	D2854HB
60"	24"	1,180#	D2810HB	D2811HB	D2910HB	D2911HB	D2855HB
60"	36"	1,520#	D2812HB	D2813HB	D2912HB	D2913HB	D2856HB
60"	48"	1,680#	D2814HB	D2815HB	D2914HB	D2915HB	D2857HB
72"	18"	1,200#	D2816HB	D2817HB	D2916HB	D2917HB	D2858HB
72"	24"	1,140#	D2818HB	D2819HB	D2918HB	D2919HB	D2859HB
72"	36"	1,330#	D2820HB	D2821HB	D2920HB	D2921HB	D2860HB
72"	48"	1,670#	D2822HB	D2823HB	D2922HB	D2923HB	D2861HB
96"	18"	1,000#	D2824HB	D2825HB	D2924HB	D2925HB	D2862HB
96"	24"	1,000#	D2826HB	D2827HB	D2926HB	D2927HB	D2863HB
96"	36"	1,000#	D2828HB	D2829HB	D2928HB	D2929HB	D2864HB
96"	48"	1,000#	D2830HB	D2831HB	D2930HB	D2931HB	D2865HB

Capacities are based on evenly distributed loads on one shelf when 5/8" Type 1-M-1 particle board is used as decking.

Rivet Wedge-Lock

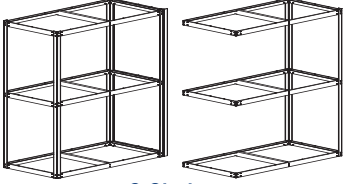
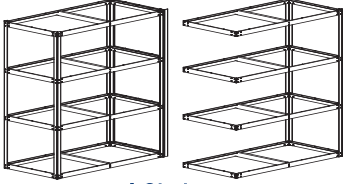
High Capacity Bulk Units 84"H							Extra shelf includes framing components necessary to add one shelf to an existing unit.
Channel Beam - wire deck			3 Shelves		4 Shelves		
W	D	Shelf Cap.	Starter	Adder	Starter	Adder	Starter
48"	18"	770#	D2800HW	D2801HW	D2900HW	D2901HW	D2850HW
48"	24"	700#	D2802HW	D2803HW	D2902HW	D2903HW	D2851HW
48"	36"	760#	D2804HW	D2805HW	D2904HW	D2905HW	D2852HW
48"	48"	920#	D2806HW	D2807HW	D2906HW	D2907HW	D2853HW
60"	18"	1,140#	D2808HW	D2809HW	D2908HW	D2909HW	D2854HW
60"	24"	1,180#	D2810HW	D2811HW	D2910HW	D2911HW	D2855HW
60"	36"	1,520#	D2812HW	D2813HW	D2912HW	D2913HW	D2856HW
60"	48"	1,680#	D2814HW	D2815HW	D2914HW	D2915HW	D2857HW
72"	18"	1,200#	D2816HW	D2817HW	D2916HW	D2917HW	D2858HW
72"	24"	1,140#	D2818HW	D2819HW	D2918HW	D2919HW	D2859HW
72"	36"	1,330#	D2820HW	D2821HW	D2920HW	D2921HW	D2860HW
72"	48"	1,670#	D2822HW	D2823HW	D2922HW	D2923HW	D2861HW
96"	18"	1,000#	D2824HW	D2825HW	D2924HW	D2925HW	D2862HW
96"	24"	1,000#	D2826HW	D2827HW	D2926HW	D2927HW	D2863HW
96"	36"	1,000#	D2828HW	D2829HW	D2928HW	D2929HW	D2864HW
96"	48"	1,000#	D2830HW	D2831HW	D2930HW	D2931HW	D2865HW
Heavy Z-Beam - no deck			3 Shelves		4 Shelves		Extra Shelf
W	D	Shelf Cap.	Starter	Adder	Starter	Adder	Starter
48"	18"	770#	DP2870H	DP2871H	DP2970H	DP2971H	DP2932H
48"	24"	700#	DP2872H	DP2873H	DP2972H	DP2973H	DP2933H
48"	36"	760#	DP2874H	DP2875H	DP2974H	DP2975H	DP2934H
48"	48"	920#	DP2876H	DP2877H	DP2976H	DP2977H	DP2935H
60"	18"	1,140#	DP2878H	DP2879H	DP2978H	DP2979H	DP2936H
60"	24"	1,180#	DP2880H	DP2881H	DP2980H	DP2981H	DP2937H
60"	36"	1,520#	DP2882H	DP2883H	DP2982H	DP2983H	DP2938H
60"	48"	1,680#	DP2884H	DP2885H	DP2984H	DP2985H	DP2939H
72"	18"	1,200#	DP2886H	DP2887H	DP2986H	DP2987H	DP2940H
72"	24"	1,140#	DP2888H	DP2889H	DP2988H	DP2989H	DP2941H
72"	36"	1,330#	DP2890H	DP2891H	DP2990H	DP2991H	DP2942H
72"	48"	1,670#	DP2892H	DP2893H	DP2992H	DP2993H	DP2943H
Heavy Z-Beam - board deck			3 Shelves		4 Shelves		Extra Shelf
W	D	Shelf Cap.	Starter	Adder	Starter	Adder	Starter
48"	18"	770#	D2870HB	DP2871HB	D2970HB	D2971HB	D2932HB
48"	24"	700#	D2872HB	D2873HB	D2972HB	D2973HB	D2933HB
48"	36"	760#	D2874HB	D2875HB	D2974HB	D2975HB	D2934HB
48"	48"	920#	D2876HB	D2877HB	D2976HB	D2977HB	D2935HB
60"	18"	1,140#	D2878HB	D2879HB	D2978HB	D2979HB	D2936HB
60"	24"	1,180#	D2880HB	D2881HB	D2980HB	D2981HB	D2937HB
60"	36"	1,520#	D2882HB	D2883HB	D2982HB	D2983HB	D2938HB
60"	48"	1,680#	D2884HB	D2885HB	D2984HB	D2985HB	D2939HB
72"	18"	1,200#	D2886HB	D2887HB	D2986HB	D2987HB	D2940HB
72"	24"	1,140#	D2888HB	D2889HB	D2988HB	D2989HB	D2941HB
72"	36"	1,330#	D2890HB	D2891HB	D2990HB	D2991HB	D2942HB
72"	48"	1,670#	D2892HB	D2893HB	D2992HB	D2993HB	D2943HB

Capacities are based on evenly distributed loads on one shelf when 5/8" Type 1-M-1 particle board is used as decking.

Rivet Wedge-Lock



Republic Rivet Wedge-Lock **archive units** provide sturdy, high-density storage of 12" x 15" x 10" document boxes for record storage. Depending on your particular application, units are available without deck, with partible board deck, or with angle track to support and guide boxes.

The units shown below feature 14 gauge angle and T-posts. Heavy duty beams are used full perimeter at all levels. Channel supports are used under each shelf to maximize capacity. Archive units will safely support 20 fully loaded boxes (maximum 40 lbs. per box) per shelf when type 1-M-1 5/8" particle board is used as a shelf deck.

Order one starter unit and the balance as adders to make up a row of shelving. Units are available from stock in color #50 Gray and from production in color #83 Decorator Tan.



#50 Gray



#83 Decorator Tan

Units ship K.D. (knocked down) from any Republic location.

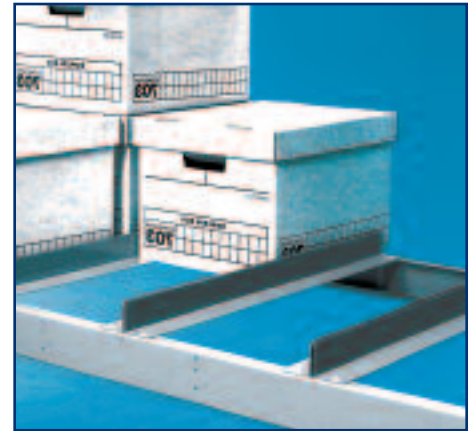

Archive Units

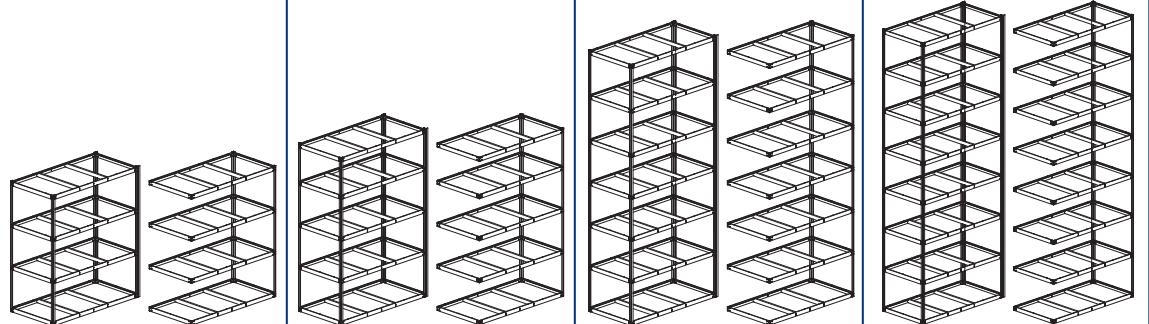

Units without Deck

W	D	H	69"	30"	84"	69"	30"	108"	69"	30"	168"	69"	30"	192"
Number of Tiers				4			5			7			8	
Number of Boxes				80			100			140			160	
Starter				DP2320			DP2326			DP2322			DP2324	
Adder				DP2321			DP2327			DP2323			DP2325	

Units with Board Deck

W	D	H	69"	30"	84"	69"	30"	108"	69"	30"	168"	69"	30"	192"
Number of Tiers				4			5			7			8	
Number of Boxes				80			100			140			160	
Starter				DP2320B			DP2326B			DP2322B			DP2324B	
Adder				DP2321B			DP2327B			DP2323B			DP2325B	

Units with Angle Track

W	D	H	69"	30"	84"	69"	30"	108"	69"	30"	168"	69"	30"	192"
Number of Tiers				4			5			7			8	
Number of Boxes				80			100			140			160	
Starter				DP2320A			DP2326A			DP2322A			DP2324A	
Adder				DP2321A			DP2327A			DP2323A			DP2325A	

Components

Stock components shown in bold.

Heavy Angle Post

6'0" high	230082
7'0" high	230086
8'0" high	230090
10'0" high	230098
12'0" high	230106
14'0" high	230114
16'0" high	230122
Splice Kit	293005

Standard T Post

6'0" high	230052
7'0" high	230056
8'0" high	230060
10'0" high	230068

Heavy T Post

6'0" high	230137
7'0" high	230141
8'0" high	230145
10'0" high	230153
12'0" high	230161
14'0" high	230169
16'0" high	230177
Splice Kit	293004

Foot Plate

2 29/32" x 1 23/32"	293000
---------------------	---------------

Standard Duty Beam

12" wide/deep	230200
18" wide/deep	230202
24" wide/deep	230204
30" wide/deep	230206
36" wide/deep	230208
48" wide/deep	230212

Medium Duty Beam

24" wide/deep	230219
36" wide/deep	230223
48" wide/deep	230227

Heavy Duty Beam

12" wide/deep	230230
15" wide/deep	230231
18" wide/deep	230232
24" wide/deep	230234
30" wide/deep	230236
36" wide/deep	230238
42" wide/deep	230240
48" wide/deep	230242
60" wide/deep	230244
69" wide/deep	230246
72" wide/deep	230247
96" wide/deep	230249

Channel Beam

48" wide/deep	230254
60" wide/deep	230256
69" wide/deep	230258
72" wide/deep	230260
96" wide/deep	230262

Low Profile Beam

12" wide/deep	230300
15" wide/deep	230301
18" wide/deep	230302
24" wide/deep	230303
30" wide/deep	230304
36" wide/deep	230305
42" wide/deep	230306
48" wide/deep	230307

Z-Beam

12" wide/deep	230310
15" wide/deep	230311
18" wide/deep	230312

24" wide/deep	230313
30" wide/deep	230314
36" wide/deep	230315
42" wide/deep	230316
48" wide/deep	230317
60" wide/deep	230318

Heavy Duty Z-Beam

48" wide/deep	230319
60" wide/deep	230320
69" wide/deep	230321
72" wide/deep	230322

Channel Support

18" deep	230267
24" deep	230269
30" deep	230271
36" deep	230273
48" deep	230277

Standard Duty Support

12" deep	220245
18" deep	220247
24" deep	220249

Heavy Duty Support

30" deep	220252
36" deep	220254
48" deep	220258

5/8" Particle Board Shelf

36" wide x 12" deep	702076
36" wide x 18" deep	702077
36" wide x 24" deep	702078
48" wide x 12" deep	702079
48" wide x 18" deep	702080
48" wide x 24" deep	702081
48" wide x 36" deep	702083
48" wide x 48" deep	702084
60" wide x 18" deep	702085
60" wide x 24" deep	702086

60" wide x 36" deep	702088
60" wide x 48" deep	702089
69" wide x 30" deep	702074
72" wide x 18" deep	702090
72" wide x 24" deep	702091
72" wide x 36" deep	702093
72" wide x 48" deep	702094
96" wide x 18" deep	702095
96" wide x 24" deep	702096
96" wide x 36" deep	702097
96" wide x 48" deep	702098

Wire Deck Shelf

36" wide x 12" deep	702151
36" wide x 18" deep	702152
36" wide x 24" deep	702153
48" wide x 12" deep	702154
48" wide x 18" deep	702155
48" wide x 24" deep	702156
48" wide x 36" deep	702157
48" wide x 48" deep	702158
60" wide x 18" deep	702159
60" wide x 24" deep	702160
60" wide x 36" deep	702161
60" wide x 48" deep	702162
72" wide x 18" deep	702163
72" wide x 24" deep	702164
72" wide x 36" deep	702165
72" wide x 48" deep	702166
96" wide x 18" deep	702167
96" wide x 24" deep	702168
96" wide x 36" deep	702169
96" wide x 48" deep	702170

Archive Angle Track

30" deep	220420
----------	--------



Original Wedge-Lock

Components

Wedge-Lock Shelf Framing Systems provide economical and versatile storage solutions for a variety of applications including retail stock rooms, auto parts centers and archive storerooms. The shelving units consist of primary framing members that snap together for easy assembly without bolts, clips or other fasteners.

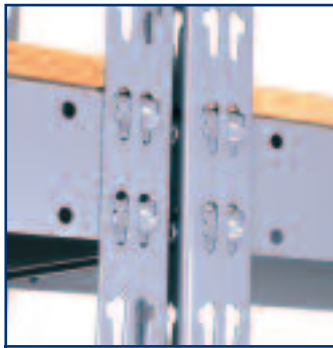

Original Connection

Shelves are accessible from all four sides because no cross-bracing is required. The Original Wedge-Lock design consists of two wedging lugs on the beam that engage tapered slots on the post for a strong, rigid connection.



Angle Post Heavy Duty Angle Post T-Post Heavy Duty T-Post

■ Angle Post

- 14 gauge angle formation
- two columns of slots for 2" vertical shelf adjustment
- used at aisle ends on standard and bulk units
- heights to 12'

■ Heavy Duty Angle Post

- 14 gauge angle formation
- two columns of slots for 2" vertical shelf adjustment
- used at aisle ends on high-capacity bulk units
- heights to 16'

■ T-Post

- 14 gauge T-formation
- four columns of slots for 2" vertical shelf adjustment
- used at intermediate positions on standard and bulk units
- heights to 12'

■ Heavy Duty T-Post

- 14 gauge T-formation
- four columns of slots for 2" vertical shelf adjustment
- used at intermediate positions on high-capacity bulk units
- heights to 16'

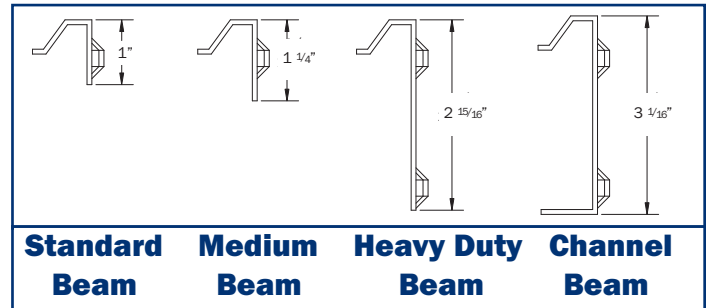

■ Standard Beam

- 14 gauge - 1" tall to support 1/2" or 5/8" particle board or plywood
- one set of double lugs stamped in end that nest in slots in post
- used at intermediate shelf locations front and back of standard units
- widths to 4'

■ Medium Beam

- 14 gauge - 1 1/4" tall to support 3/4" or 7/8" particle board or plywood
- one set of double lugs stamped in end that nest in slots in post
- used at intermediate shelf locations front and back of standard units with thicker deck material
- widths to 4'

■ Heavy Duty Beam

- 14 gauge - 2 15/16" tall
- two sets of double lugs for improved strength and stability
- used top, bottom full perimeter and front-to-back intermediate on standard units
- used full perimeter at all levels on bulk units
- used front-to-back at all levels on high-capacity bulk units
- widths to 8'

■ Channel Beam

- 14 gauge - 3 1/16" tall with 7/8" return flange on bottom of beam
- two sets of double lugs for improved strength and stability
- used side-to-side at all levels on high-capacity bulk units
- widths to 8'

Special Archive Record Units for storing document boxes are also available from the Original Wedge-Lock product line.

Original Wedge-Lock



Standard units provide sturdy, basic storage at an affordable price. A variety of sizes, capacities and shelf levels offer versatile storage in commercial or industrial applications.

The units shown below feature 14 gauge angle and T-posts. Heavy duty beams are used full perimeter at the top and bottom of the unit for stability; standard beams are used side-to-side at intermediate shelf levels. Units are available with framing only, with $\frac{5}{8}$ " particle board deck or with wire deck.

Order one starter unit and the balance as adders to make up a row of shelving. Units are available from stock in color #50 Gray and from production in color #83 Decorator Tan.

Units ship K.D. (knocked down) from Republic's Canton, OH facility.



#50 Gray



#83 Decorator Tan

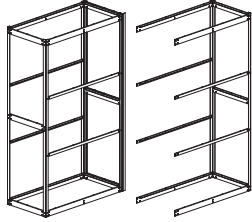
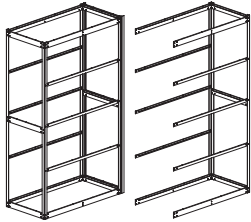
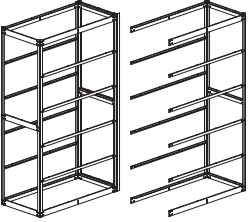
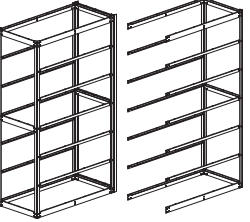

Standard Units										
84" H - no deck			4 Shelves		5 Shelves		6 Shelves		7 Shelves	
W	D	Shelf Cap.	Starter	Adder	Starter	Adder	Starter	Adder	Starter	Adder
36"	12"	425#	DP2100	DP2101	DP2112	DP2113	DP2124	DP2125	DP2136	DP2137
36"	18"	400#	DP2102	DP2103	DP2114	DP2115	DP2126	DP2127	DP2138	DP2139
36"	24"	305#	DP2104	DP2105	DP2116	DP2117	DP2128	DP2129	DP2140	DP2141
48"	12"	310#	DP2106	DP2107	DP2118	DP2119	DP2130	DP2131	DP2142	DP2143
48"	18"	310#	DP2108	DP2109	DP2120	DP2121	DP2132	DP2133	DP2144	DP2145
48"	24"	310#	DP2110	DP2111	DP2122	DP2123	DP2134	DP2135	DP2146	DP2147
84" H - board deck			4 Shelves		5 Shelves		6 Shelves		7 Shelves	
W	D	Capacity	Starter	Adder	Starter	Adder	Starter	Adder	Starter	Adder
36"	12"	425#	DP2100B	DP2101B	DP2112B	DP2113B	DP2124B	DP2125B	DP2136B	DP2137B
36"	18"	400#	DP2102B	DP2103B	DP2114B	DP2115B	DP2126B	DP2127B	DP2138B	DP2139B
36"	24"	305#	DP2104B	DP2105B	DP2116B	DP2117B	DP2128B	DP2129B	DP2140B	DP2141B
48"	12"	310#	DP2106B	DP2107B	DP2118B	DP2119B	DP2130B	DP2131B	DP2142B	DP2143B
48"	18"	310#	DP2108B	DP2109B	DP2120B	DP2121B	DP2132B	DP2133B	DP2144B	DP2145B
48"	24"	310#	DP2110B	DP2111B	DP2122B	DP2123B	DP2134B	DP2135B	DP2146B	DP2147B
84" H - wire deck			4 Shelves		5 Shelves		6 Shelves		7 Shelves	
W	D	Capacity	Starter	Adder	Starter	Adder	Starter	Adder	Starter	Adder
36"	12"	425#	DP2100W	DP2101W	DP2112W	DP2113W	DP2124W	DP2125W	DP2136W	DP2137W
36"	18"	400#	DP2102W	DP2103W	DP2114W	DP2115W	DP2126W	DP2127W	DP2138W	DP2139W
36"	24"	305#	DP2104W	DP2105W	DP2116W	DP2117W	DP2128W	DP2129W	DP2140W	DP2141W
48"	12"	310#	DP2106W	DP2107W	DP2118W	DP2119W	DP2130W	DP2131W	DP2142W	DP2143W
48"	18"	310#	DP2108W	DP2109W	DP2120W	DP2121W	DP2132W	DP2133W	DP2144W	DP2145W
48"	24"	310#	DP2110W	DP2111W	DP2122W	DP2123W	DP2134W	DP2135W	DP2146W	DP2147W

Capacities are based on 1/2" APA C-D Plugged, Group 1, Exp. 1 plywood (with grain running in depth direction) or Type 1-M-1, 5/8" particle board.

Original Wedge-Lock

Original Wedge-Lock **bulk units** have a greater shelf area than standard units, making them ideal for storing large or odd-sized items. The wide range of shelf sizes and capacities, combined with the option of adding extra shelves, allows you to design the bulk shelving system that best meets your needs.

Bulk units feature 14 gauge heavy duty angle and heavy duty T-posts. Heavy duty beams are used full perimeter at all levels on bulk units. Beams are punched to accept front-to-

rear supports supplied with units 36" and 48" deep. Units are available with framing only, with 5/8" particle board deck or with wire deck.

Order one starter unit and the balance as adders to make up a row of shelving. Units are available from stock in color #50 Gray and from production in color #83 Decorator Tan. Units ship K.D. (knocked down) from Republic's Canton, OH facility.



#50 Gray



#83 Decorator Tan

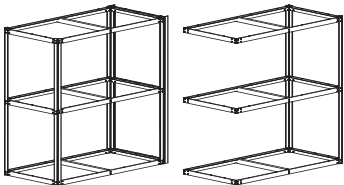
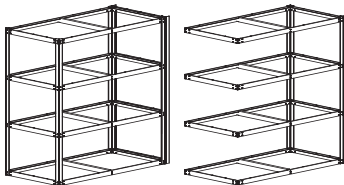

Bulk Units 84"H							Extra shelf includes framing components necessary to add one shelf to an existing unit.
Heavy Beam - no deck			3 Shelves		4 Shelves		
W	D	Shelf Cap.	Starter	Adder	Starter	Adder	Starter
48"	18"	760#	DP2200	DP2201	DP2500	DP2501	DP2280
48"	24"	560#	DP2202	DP2203	DP2502	DP2503	DP2281
48"	36"	760#	DP2204	DP2205	DP2504	DP2505	DP2282
48"	48"	920#	DP2206	DP2207	DP2506	DP2507	DP2283
60"	18"	840#	DP2208	DP2209	DP2508	DP2509	DP2284
60"	24"	700#	DP2210	DP2211	DP2510	DP2511	DP2285
60"	36"	670#	DP2212	DP2213	DP2512	DP2513	DP2286
60"	48"	750#	DP2214	DP2215	DP2514	DP2515	DP2287
72"	18"	1,000#	DP2216	DP2217	DP2516	DP2517	DP2288
72"	24"	770#	DP2218	DP2219	DP2518	DP2519	DP2289
72"	36"	660#	DP2220	DP2221	DP2520	DP2521	DP2290
72"	48"	690#	DP2222	DP2223	DP2522	DP2523	DP2291
96"	18"	900#	DP2224	DP2225	DP2524	DP2525	DP2292
96"	24"	900#	DP2226	DP2227	DP2526	DP2527	DP2293
96"	36"	900#	DP2228	DP2229	DP2528	DP2529	DP2294
96"	48"	900#	DP2230	DP2231	DP2530	DP2531	DP2295
Heavy Beam - board deck			3 Shelves		4 Shelves		Extra Shelf
W	D	Shelf Cap.	Starter	Adder	Starter	Adder	Starter
48"	18"	760#	DP2200B	DP2201B	DP2500B	DP2501B	DP2280B
48"	24"	560#	DP2202B	DP2203B	DP2502B	DP2503B	DP2281B
48"	36"	760#	DP2204B	DP2205B	DP2504B	DP2505B	DP2282B
48"	48"	920#	DP2206B	DP2207B	DP2506B	DP2507B	DP2283B
60"	18"	840#	DP2208B	DP2209B	DP2508B	DP2509B	DP2284B
60"	24"	700#	DP2210B	DP2211B	DP2510B	DP2511B	DP2285B
60"	36"	670#	DP2212B	DP2213B	DP2512B	DP2513B	DP2286B
60"	48"	750#	DP2214B	DP2215B	DP2514B	DP2515B	DP2287B
72"	18"	1,000#	DP2216B	DP2217B	DP2516B	DP2517B	DP2288B
72"	24"	770#	DP2218B	DP2219B	DP2518B	DP2519B	DP2289B
72"	36"	660#	DP2220B	DP2221B	DP2520B	DP2521B	DP2290B
72"	48"	690#	DP2222B	DP2223B	DP2522B	DP2523B	DP2291B
96"	18"	900#	DP2224B	DP2225B	DP2524B	DP2525B	DP2292B
96"	24"	900#	DP2226B	DP2227B	DP2526B	DP2527B	DP2293B
96"	36"	900#	DP2228B	DP2229B	DP2528B	DP2529B	DP2294B
96"	48"	900#	DP2230B	DP2231B	DP2530B	DP2531B	DP2295B

Capacities are based on evenly distributed loads on one shelf when 5/8" Type 1-M-1 particle board is used as decking.

Original Wedge-Lock

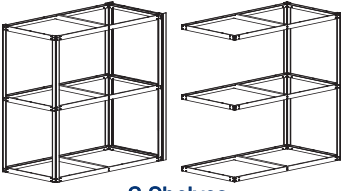
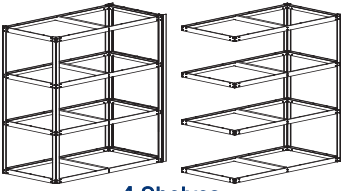
Bulk Units 84"H							Extra shelf includes framing components necessary to add one shelf to an existing unit.
Heavy Beam - wire deck			3 Shelves		4 Shelves		
W	D	Shelf Cap.	Starter	Adder	Starter	Adder	Starter
48"	18"	760#	DP2200W	DP2201W	DP2500W	DP2501W	DP2280W
48"	24"	560#	DP2202W	DP2203W	DP2502W	DP2503W	DP2281W
48"	36"	760#	DP2204W	DP2205W	DP2504W	DP2505W	DP2282W
48"	48"	920#	DP2206W	DP2207W	DP2506W	DP2507W	DP2283W
60"	18"	840#	DP2208W	DP2209W	DP2508W	DP2509W	DP2284W
60"	24"	700#	DP2210W	DP2211W	DP2510W	DP2511W	DP2285W
60"	36"	670#	DP2212W	DP2213W	DP2512W	DP2513W	DP2286W
60"	48"	750#	DP2214W	DP2215W	DP2514W	DP2515W	DP2287W
72"	18"	1,000#	DP2216W	DP2217W	DP2516W	DP2517W	DP2288W
72"	24"	770#	DP2218W	DP2219W	DP2518W	DP2519W	DP2289W
72"	36"	660#	DP2220W	DP2221W	DP2520W	DP2521W	DP2290W
72"	48"	690#	DP2222W	DP2223W	DP2522W	DP2523W	DP2291W
96"	18"	900#	DP2224W	DP2225W	DP2524W	DP2525W	DP2292W
96"	24"	900#	DP2226W	DP2227W	DP2526W	DP2527W	DP2293W
96"	36"	900#	DP2228W	DP2229W	DP2528W	DP2529W	DP2294W
96"	48"	900#	DP2230W	DP2231W	DP2530W	DP2531W	DP2295W

When extra capacity is needed, upgrade to **high-capacity bulk units**. Shelves can carry up to double the load of regular bulk units. Extra shelves can be added for additional storage area and capacity.

High-capacity bulk units feature 14 ga. heavy duty angle and heavy duty T-posts.

Channel beams are used side-to-side on high-capacity bulk units. Beams are punched to accept front-to-rear supports supplied with units 36" and 48" deep. Units are available with framing only, with 5/8" particle board deck or with wire deck.

Order one starter unit and the balance as adders to make up a row of shelving.

Units are available from stock in #50 Gray and from production in #83 Decorator Tan. Units ship K.D. (knocked down) from Republic's Canton, OH facility.

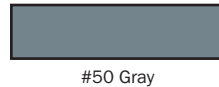

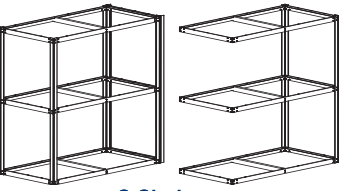
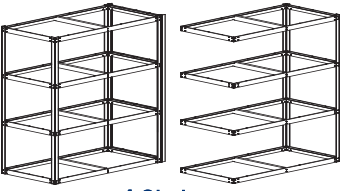
High Capacity Bulk Units 84"H							Extra shelf includes framing components necessary to add one shelf to an existing unit.
Channel Beam - no deck			3 Shelves		4 Shelves		
W	D	Shelf Cap.	Starter	Adder	Starter	Adder	Starter
48"	18"	770#	DP2200H	DP2201H	DP2500H	DP2501H	DP2280H
48"	24"	700#	DP2202H	DP2203H	DP2502H	DP2503H	DP2281H
48"	36"	760#	DP2204H	DP2205H	DP2504H	DP2505H	DP2282H
48"	48"	920#	DP2206H	DP2207H	DP2506H	DP2507H	DP2283H
60"	18"	1,140#	DP2208H	DP2209H	DP2508H	DP2509H	DP2284H
60"	24"	1,180#	DP2210H	DP2211H	DP2510H	DP2511H	DP2285H
60"	36"	1,520#	DP2212H	DP2213H	DP2512H	DP2513H	DP2286H
60"	48"	1,680#	DP2214H	DP2215H	DP2514H	DP2515H	DP2287H
72"	18"	1,200#	DP2216H	DP2217H	DP2516H	DP2517H	DP2288H
72"	24"	1,140#	DP2218H	DP2219H	DP2518H	DP2519H	DP2289H
72"	36"	1,330#	DP2220H	DP2221H	DP2520H	DP2521H	DP2290H
72"	48"	1,670#	DP2222H	DP2223H	DP2522H	DP2523H	DP2291H
96"	18"	1,500#	DP2224H	DP2225H	DP2524H	DP2525H	DP2292H
96"	24"	1,200#	DP2226H	DP2227H	DP2526H	DP2527H	DP2293H
96"	36"	1,150#	DP2228H	DP2229H	DP2528H	DP2529H	DP2294H
96"	48"	1,330#	DP2230H	DP2231H	DP2530H	DP2531H	DP2295H

Capacities are based on evenly distributed loads on one shelf when 5/8" Type 1-M-1 particle board is used as decking.

Original Wedge-Lock

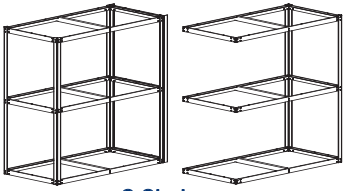
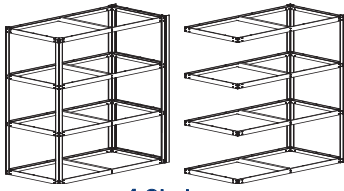
High Capacity Bulk Units 84"H			 3 Shelves		 4 Shelves		Extra shelf includes framing components necessary to add one shelf to an existing unit.
Channel Beam - board deck			3 Shelves		4 Shelves		Extra Shelf
W	D	Shelf Cap.	Starter	Adder	Starter	Adder	Starter
48"	18"	770#	D2200HB	D2201HB	D2500HB	D2501HB	D2280HB
48"	24"	700#	D2202HB	D2203HB	D2502HB	D2503HB	D2281HB
48"	36"	760#	D2204HB	D2205HB	D2504HB	D2505HB	D2282HB
48"	48"	920#	D2206HB	D2207HB	D2506HB	D2507HB	D2283HB
60"	18"	1,140#	D2208HB	D2209HB	D2508HB	D2509HB	D2284HB
60"	24"	1,180#	D2210HB	D2211HB	D2510HB	D2511HB	D2285HB
60"	36"	1,520#	D2212HB	D2213HB	D2512HB	D2513HB	D2286HB
60"	48"	1,680#	D2214HB	D2215HB	D2514HB	D2515HB	D2287HB
72"	18"	1,200#	D2216HB	D2217HB	D2516HB	D2517HB	D2288HB
72"	24"	1,140#	D2218HB	D2219HB	D2518HB	D2519HB	D2289HB
72"	36"	1,330#	D2220HB	D2221HB	D2520HB	D2521HB	D2290HB
72"	48"	1,670#	D2222HB	D2223HB	D2522HB	D2523HB	D2291HB
96"	18"	1,500#	D2224HB	D2225HB	D2524HB	D2525HB	D2292HB
96"	24"	1,200#	D2226HB	D2227HB	D2526HB	D2527HB	D2293HB
96"	36"	1,150#	D2228HB	D2229HB	D2528HB	D2529HB	D2294HB
96"	48"	1,330#	D2230HB	D2231HB	D2530HB	D2531HB	D2295HB
Channel Beam - wire deck			3 Shelves		4 Shelves		Extra Shelf
W	D	Shelf Cap.	Starter	Adder	Starter	Adder	Starter
48"	18"	770#	D2200HW	D2201HW	D2500HW	D2501HW	D2280HW
48"	24"	700#	D2202HW	D2203HW	D2502HW	D2503HW	D2281HW
48"	36"	760#	D2204HW	D2205HW	D2504HW	D2505HW	D2282HW
48"	48"	920#	D2206HW	D2207HW	D2506HW	D2507HW	D2283HW
60"	18"	1,140#	D2208HW	D2209HW	D2508HW	D2509HW	D2284HW
60"	24"	1,180#	D2210HW	D2211HW	D2510HW	D2511HW	D2285HW
60"	36"	1,520#	D2212HW	D2213HW	D2512HW	D2513HW	D2286HW
60"	48"	1,680#	D2214HW	D2215HW	D2514HW	D2515HW	D2287HW
72"	18"	1,200#	D2216HW	D2217HW	D2516HW	D2517HW	D2288HW
72"	24"	1,140#	D2218HW	D2219HW	D2518HW	D2519HW	D2289HW
72"	36"	1,330#	D2220HW	D2221HW	D2520HW	D2521HW	D2290HW
72"	48"	1,670#	D2222HW	D2223HW	D2522HW	D2523HW	D2291HW
96"	18"	1,500#	D2224HW	D2225HW	D2524HW	D2525HW	D2292HW
96"	24"	1,200#	D2226HW	D2227HW	D2526HW	D2527HW	D2293HW
96"	36"	1,150#	D2228HW	D2229HW	D2528HW	D2529HW	D2294HW
96"	48"	1,330#	D2230HW	D2231HW	D2530HW	D2531HW	D2295HW

Capacities are based on evenly distributed loads on one shelf when 5/8" Type 1-M-1 particle board is used as decking.

Components

Stock components shown in bold.

Standard Angle Post

6'0" high	220021
7'0" high	220027
8'0" high	220033
10'0" high	220045

Heavy Angle Post

6'0" high	220313
7'0" high	220319
8'0" high	220325
10'0" high	220337
12'0" high	220349
14'0" high	220361
16'0" high	220405
Splice Kit	292004

Standard T Post

6'0" high	220079
7'0" high	220085
8'0" high	220091
10'0" high	220103

Heavy T Post

6'0" high	220137
7'0" high	220143
8'0" high	220149
10'0" high	220161
12'0" high	220173
14'0" high	220185
16'0" high	220402
Splice Kit	292006

Foot Plate

2 ²⁹ / ₃₂ " x 1 ²³ / ₃₂ "	292001
---	---------------

Standard Duty Beam

12" wide/deep	220193
18" wide/deep	220195
24" wide/deep	220197
30" wide/deep	220199
36" wide/deep	220201
48" wide/deep	220205

Medium Duty Beam

24" wide/deep	220210
36" wide/deep	220214
48" wide/deep	220218

Heavy Duty Beam

12" wide/deep	220220
15" wide/deep	220221
18" wide/deep	220222
24" wide/deep	220224
30" wide/deep	220226
36" wide/deep	220228
42" wide/deep	220230
48" wide/deep	220232
60" wide/deep	220234
69" wide/deep	220236
72" wide/deep	220237
96" wide/deep	220239

Channel Beam

48" wide/deep	220240
60" wide/deep	220241
69" wide/deep	220371
72" wide/deep	220242
96" wide/deep	220244

Channel Support

18" deep	230267
24" deep	230269
30" deep	230271
36" deep	230273
48" deep	230277

Standard Duty Support

12" deep	220245
18" deep	220247
24" deep	220249

Heavy Duty Support

30" deep	220252
36" deep	220254
48" deep	220258

5/8" Particle Board Shelf

36" wide x 12" deep	702076
36" wide x 18" deep	702077
36" wide x 24" deep	702078
48" wide x 12" deep	702079
48" wide x 18" deep	702080
48" wide x 24" deep	702081
48" wide x 36" deep	702083
48" wide x 48" deep	702084
60" wide x 18" deep	702085
60" wide x 24" deep	702086
60" wide x 36" deep	702088
60" wide x 48" deep	702089
72" wide x 18" deep	702090
72" wide x 24" deep	702091
72" wide x 36" deep	702093
72" wide x 48" deep	702094
96" wide x 18" deep	702095
96" wide x 24" deep	702096
96" wide x 36" deep	702097
96" wide x 48" deep	702098

Wire Deck Shelf

36" wide x 12" deep	702151
36" wide x 18" deep	702152
36" wide x 24" deep	702153
48" wide x 12" deep	702154
48" wide x 18" deep	702155
48" wide x 24" deep	702156
48" wide x 36" deep	702157
48" wide x 48" deep	702158
60" wide x 18" deep	702159
60" wide x 24" deep	702160
60" wide x 36" deep	702161
60" wide x 48" deep	702162
72" wide x 18" deep	702163
72" wide x 24" deep	702164
72" wide x 36" deep	702165
72" wide x 48" deep	702166
96" wide x 18" deep	702167
96" wide x 24" deep	702168
96" wide x 36" deep	702169
96" wide x 48" deep	702170



Keystone Storage Rack

Components



Republic's **Storage Rack Systems** are engineered and designed for optimum safety, strength, reliability and value. Strict attention to detail and rigid quality control standards result in reliable performance, even under the most demanding conditions.

Rack systems are easy to design and install because they consist of just two basic components: beams and upright frames. With a wide range of sizes, capacities and accessories, Republic provides a flexible system that can be adapted to accommodate any number of storage needs.

Efficient one-piece beam design uses double steel thickness on top for additional strength.

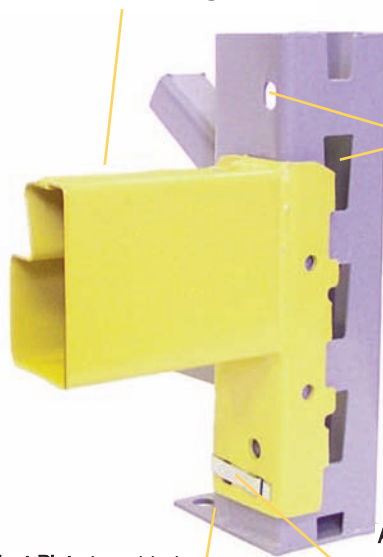

Keystone Slots and Safety Clip Holes are offset for maximum column strength. The keystone design protects against metal tearing, resists side loading and reduces secondary stress.

Foot Plate is welded to post for maximum strength and impact resistance.

Automatic Safety Lock Clip prevents accidental beam uplift and allows for a visible safety check from the front of the rack.

Upright frames are designed for structural strength and durability. Keystone slots are punched into columns at the area of least stress for maximum load carrying capacity. Heavy duty U-shaped horizontal and diagonal bracing members are welded into Z-pattern panels for maximum strength. Keystone upright frames offer 3" vertical beam adjustment capability.

Uprights		3" x 1 5/8" Post - 14 ga.		3" x 3" Post - 14 ga.	
H	D	Capacity	Part Number	Capacity	Part Number
96"	36"	15,200#	601178	21,100#	603178
96"	42"	15,200#	601180	21,100#	603180
96"	44"	15,200#	601181	21,100#	603181
96"	48"	15,200#	601182	21,100#	603182
120"	36"	14,500#	601266	19,600#	603266
120"	42"	14,500#	601268	19,600#	603268
120"	44"	14,500#	601269	19,600#	603269
120"	48"	14,500#	601270	19,600#	603270
144"	36"	13,500#	601352	18,800#	603352
144"	42"	13,500#	601354	18,800#	603354
144"	44"	13,500#	601355	18,800#	603355
144"	48"	13,500#	601356	18,800#	603356
192"	36"	--	--	18,800#	603530
192"	42"	--	--	18,800#	603532
192"	44"	--	--	18,800#	603533
192"	48"	--	--	18,800#	603534

All upright capacities are based on a 54" maximum vertical beam spacing. 13 ga. and 12 ga. uprights are available; call for information. Production uprights are available from 6' to 24' heights in 1' increments.

Republic **offset beams and connectors** are designed for optimum strength-to-weight ratio. The lapped top surface of the beam provides double metal thickness at the load point to withstand greater impacts. The heavy duty 7 gauge beam connector's one-piece design and slip-fit lugs promote quick, easy installation. A flush front beam design eliminates aisle projections that may damage equipment or merchandise.

		Beam - 96" Clear Span			Beam - 108" Clear Span		
H	Deflection	Cap./Pair	Part No.	Deflection	Cap./Pair	Part No.	
3 1/2"	0.53	4,100#	623096	--	--	--	
3 3/4"	0.50	4,700#	623296	0.60	4,000#	623308	
4 1/4"	0.44	5,600#	623496	0.56	5,000#	623508	
4 3/4"	0.40	6,700#	623696	0.50	6,000#	623708	
5 1/4"	0.36	7,800#	623896	0.45	6,900#	623908	
		Beam - 120" Clear Span			Beam - 144" Clear Span		
H	Deflection	Cap./Pair	Part No.	Deflection	Cap./Pair	Part No.	
4 3/4"	0.62	5,400#	623720	0.80	3,900#	623744	

Capacity refers to safe, uniformly distributed load per pair of beams. Deflections shown are at rated capacity and do not exceed Span/180. Bracing bolts are recommended and may be required when using cross bars or drop in types of decking with beams 120" or greater in length. Contact Republic for pricing and availability.

Keystone Storage Rack

Accessories

Use Republic rack accessories to complete your storage rack installation. Cross bars fit between beams to support deck material or pallet loads smaller than the upright depth. 14 gauge plain cross bars rest on the offset of the beam. 14 gauge lap cross bars are formed with a flap at the front and rear that overlaps the beam and prevents the bar from being twisted out of place.



Plain Cross Bars

D	Deflection	Capacity	Part No.
36"	0.09	1,460#	6250032
42"	0.12	1,220#	6250038
44"	0.14	1,150#	6250040
48"	0.17	1,050#	6250044

Lap Cross Bars

D	Deflection	Capacity	Part No.
42"	0.12	1,220#	6250942
44"	0.14	1,150#	6250944
48"	0.17	1,050#	6250948

Row spacers are used to tie back-to-back rack sections together. They are formed from 14 gauge channels with tabs at each end that connect spacers to upright posts.



Rigid Row Spacers

D	Part Number
6"	6251906
12"	6251912

Wall spacers tie rack sections to the building structure. They are formed from 14 gauge channels with tabs at one end to connect to upright post and a 6" x 6" plate welded to the other end that is anchored to the wall.



Rigid Wall Spacers

D	Part Number
6"	6251807
12"	6251813

Post protectors guard uprights against impact damage from forklift trucks. Clip-on post protectors attach directly to uprights while free standing post protectors wrap around the uprights and are bolted to the floor for maximum protection.



Clip-on Post Protector

Size	Part Number
24" x 7 gauge steel	622995

Free Standing Post Protector

D	Part Number
12" x 1/4" plate	623002
18" x 1/4" plate	623003

Shims are used to level rack systems on uneven floors. They are made of 11 gauge steel and are available for both 3" x 1 5/8" and 3" x 3" upright posts.

Shims

Size	Part Number
For 3" x 1 5/8" post	621950
For 3" x 3" post	621951

Other accessories available from Republic include: wire and steel decking; drum cradles; reel supports; fork entry bars and skid channels. Call Republic for pricing and availability.



Shelving Mezzanine Systems

■ If your organization is experiencing growth, then chances are you face costly land acquisitions, steep construction costs or expensive leased space. Republic shelving supported mezzanines and multi-level systems offer a cost effective storage solution to today's expansion needs. Take advantage of your existing vertical space and save substantially by installing a Republic shelving mezzanine system.

■ Republic Storage Systems has nearly 100 years of history in the production of standard and custom designed systems. Let our experienced engineering staff design a shelving system to fit your specific needs and budget. To assure you of the utmost structural integrity and safety, all designs are performed under the direct supervision of a Professional Engineer. Our designs comply with AISC and AISI specifications as well as applicable building codes.

Multi-Level Shelving

■ **Multi-level shelving systems with catwalks are ideal for increasing the capacity of shelf storage installations. In most cases, the catwalk supports can be fastened to shelving or rack uprights, eliminating the need for free standing columns. When necessary, additional structural columns are used to support the mezzanine framing members.**

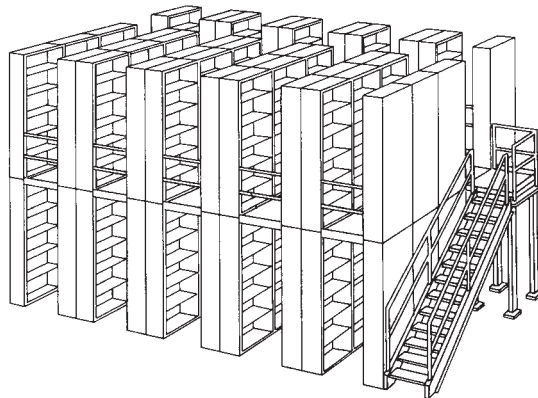

Deck Over Shelving

■ **Deck over shelving supported mezzanine structures combine the features of both the Free Standing and multi-level styles. Like multi-level shelving, deck supports can be installed onto existing shelving uprights. As with Free Standing Mezzanines, the upper level is free for storage, assembly activities, office space or other applications.**

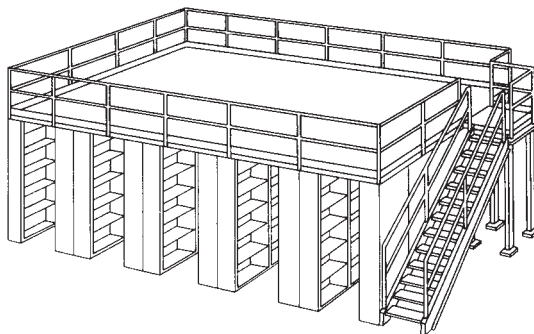

Deck Surfaces

Steel Bar Grating - 1" x 1/8" steel bar grating offers an 82% open area allowing light and ventilation to penetrate. Frequently, the need for a lower level sprinkler is eliminated.

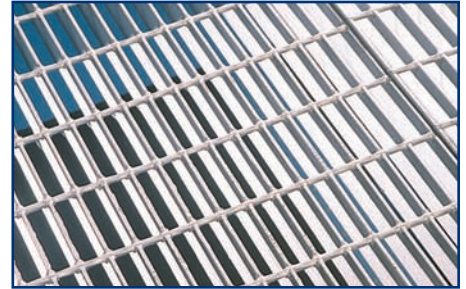

Roof deck with plywood floor provides a smooth surface on which to walk or roll carts. Roof deck is 1 1/2" deep, 20 gauge steel (18 ga. is optional); plywood floor covering is 3/4" thick. Polyethylene coated plywood, resin floors and fire retardant plywood products are available.

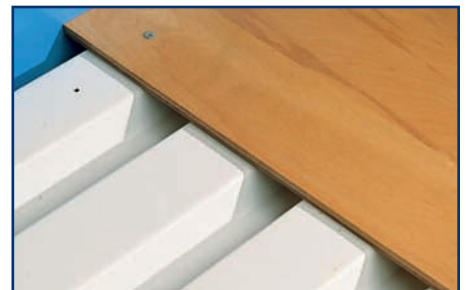

Roof Deck/Steel Floor - easy to clean, this is a natural choice for pharmaceutical, food processing and chemical plants as well as other applications that involve frequent clean up. 12 gauge steel floor plate is available with diamond texture or smooth finish.



Field poured concrete and plank grating decks are also available.

Work Benches

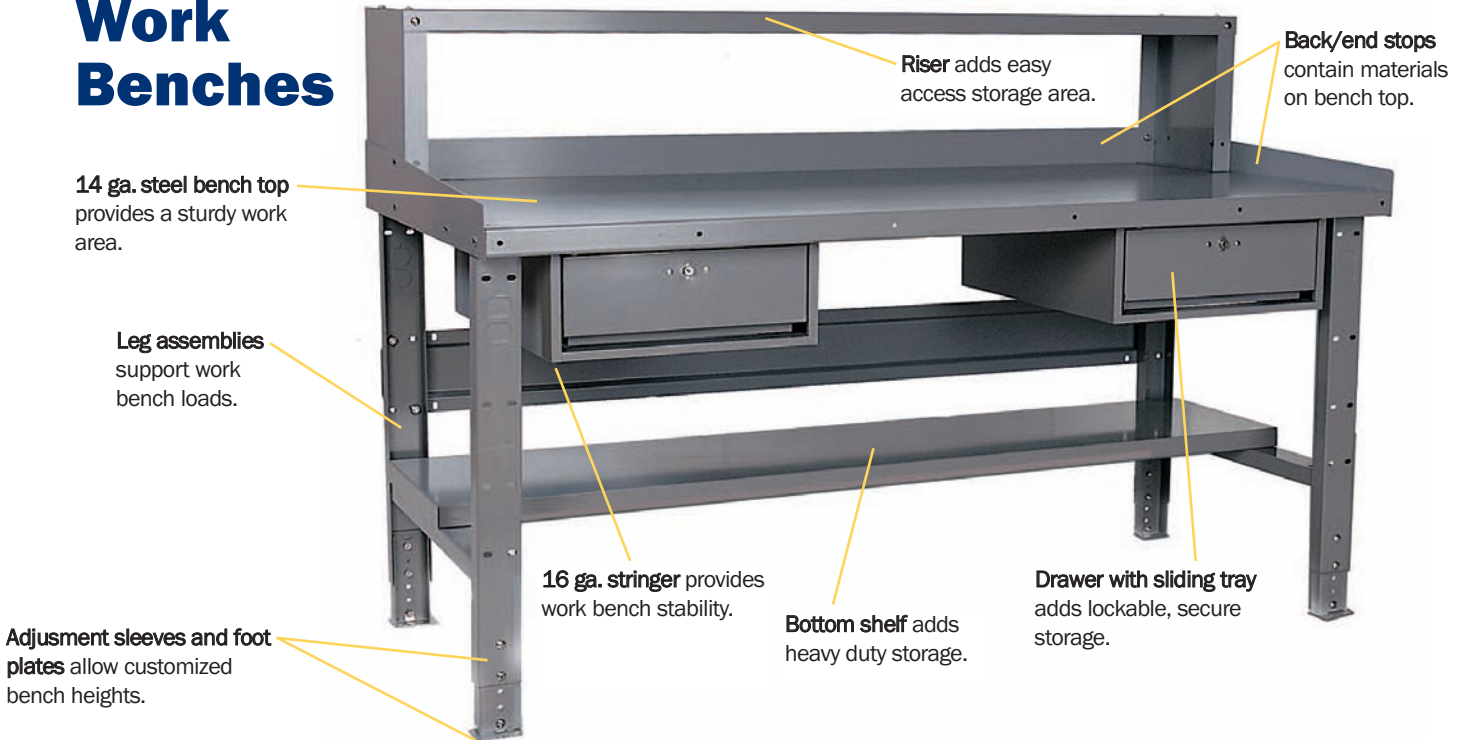

Republic **Work Benches** are versatile and durable, with styles to meet a variety of work area needs. Choose from three pre-configured work bench units or design your own work bench to suit specific applications and needs.

The basic work bench consists of a steel top, fixed bench leg assemblies and a stringer for stability. The 13 gauge steel top is pre-punched to accept leg assemblies, drawers and back/end stops. Leg assemblies consist of two 14 gauge channel shaped legs and one each 14 gauge top and bottom connecting members, all welded together. Stringers are 16 gauge, punched at ends to attach to leg assemblies.

- **Configuration A - Legs, Steel Top, Stringer**
- **Configuration B - Legs, Steel Top, Stringer, Shelf, Drawer, Back/End Stops**
- **Configuration C - Legs, Steel Top, Stringer, Shelf, Back/End Stops, two Drawers, Riser**

Work Bench Units					
W	D	H	Config. A	Config. B.	Config. C.
60"	28"	28 1/4"	DP4509	DP4605	DP4701
60"	34"	28 1/4"	DP4513	DP4609	DP4705
60"	28"	32 1/4"	DP4517	DP4613	DP4709
60"	34"	32 1/4"	DP4521	DP4617	DP4713
72"	28"	28 1/4"	DP4525	DP4621	DP4717
72"	34"	28 1/4"	DP4529	DP4625	DP4721
72"	28"	32 1/4"	DP4533	DP4629	DP4725
72"	34"	32 1/4"	DP4537	DP4633	DP4729

Accessories can be used to adapt the basic work bench to meet the unique requirements of your application. Work bench heights are easily changed by adding height adjustment sleeves, foot plates or casters to the work bench configuration. Risers create more topside storage. Back/end stops contain materials on top of the work bench. Shelves and drawers create additional storage. Drawers mounted under the work bench top accept padlocks or built-in key locks. Shelves attach easily to lower cross members of the legs.

Work Bench Accessories				
Component	W	D	H	Part Number
Height Adjustment Sleeve	2 3/8"	1 1/8"	6"	402616
Foot Plate (floor anchors not included)	2 7/8"	2 1/8"	3/32"	402617
Caster Base Height Adjustment Sleeve	2 3/8"	1 1/8"	6 3/32"	102614
Rigid Caster	4" diameter			701538
Swivel Caster with Brake	4" diameter			701539
Back/End Stops	60"	28"	3"	402560
	72"	28"	3"	402561
	60"	34"	3"	402563
	72"	34"	3"	402564
Risers	60"	10 1/2"	12"	402573
	72"	10 1/2"	12"	402574
Bottom Shelves	60"	13"	-	402569
	72"	13"	-	402570
Drawer with Sliding Tray	16"	20"	6 3/4"	402760
	22"	20"	6 3/4"	402761
Drawer Mounting Angles (two required per drawer)	For 28" depth			401111
	For 34" depth			401112
Flat Key Drawer Lock	-	-	-	
Spring Bolt	-	-	-	700629
Dead Bolt	-	-	-	700630
Master Key	-	-	-	700635

Shop & Office Storage

Storage Cabinets



Republic **Storage Cabinets** are ideal for office or back room storage of employee belongings, office supplies and stationery. Cabinet doors open a full 180 degrees for complete, easy access. A pan type door reinforcement adds strength while a three-point locking system provides security.



Full height cabinets have four adjustable shelves; counter high cabinets have two shelves. Extra shelves may be purchased separately for either unit.

Wardrobe cabinets include one shelf and a coat rod. A wardrobe cabinet is easily modified by adding an interior kit that contains a partition and four half-width shelves.

Unit	W	D	H	Part Number
Double Door Full Height	36"	18"	78"	538020
	36"	25 1/4"	78"	538030
Double Door Counter Height	36"	18"	42"	538040
	36"	25 1/4"	42"	538050
Double Door Wardrobe	36"	18"	78"	538021
	36"	25 1/4"	78"	538031
Component	W	D	H	Part Number
Extra Shelves	36"	18"	--	538024
	36"	25 1/4"	--	538034
Wardrobe Interior Kit	36"	18"	78"	538022
	36"	25 1/4"	78"	538032

Shop & Office Storage products ship K.D. (knocked down) from Republic's Canton, OH facility. Work Bench units and accessories are available from stock in #50 Gray and from production in #83 Decorator Tan. Cabinets and Book Units are available from stock in #50 Gray and #83 Decorator Tan. Spray finish colors are available from production; call for details. Stock parts are shown in bold.

Book Units

Republic **Book Units** combine the strength of steel with furniture quality appearance for storing books, catalogs, directories and other printed materials. Full height book units come with six shelves; counter high units have two shelves. Book units have slotted uprights that allow for a 1 1/2" vertical shelf adjustment to allow for storage of various sized items.

Individual book units can be combined for back-to-back and side-to-side installations. Connecting hardware kits are required for side-to-side attachment of units.

End panels are used to provide a clean, finished appearance on book unit installations. Single face end panels are used to finish individual units or a single row of units. Double face end panels finish units placed back-to-back.

Unit	W	D	H	Part Number
Counter High Book Unit	37 1/2"	9"	42"	526551
	37 1/2"	12"	42"	526553
Full Height Book Unit	37 1/2"	9"	84"	526571
	37 1/2"	12"	84"	526573
Component	W	D	H	Part Number
Single Face End Panel	--	9"	78"	526631
	--	12"	78"	526632
	--	9"	42"	526633
	--	12"	42"	526634
Double Face End Panel	--	18"	78"	526641
	--	24"	78"	526642
	--	18"	78"	526643
	--	24"	78"	526644
Connecting Hardware Kit	--	--	--	596499



#50 Gray



#83 Decorator Tan



Put the strength of steel into your custom structures with **Metal Lumber® Slotted Angle** from Republic. Metal Lumber can be incorporated into a variety of applications, including custom shelving and rack systems, framing for machinery or work stations, support framing for mezzanine structures, platforms, multi-level or high-rise shelving, and specialized shop equipment.

For heavy duty requirements, 12 gauge 3" wide angles are available. For general applications, choose from 2 1/4" or 1 1/2" wide 14 gauge angles. Cut marks on 3" centers assure quick, accurate cuts and minimize scrap material. Connector plates and corner braces add strength and support to any Metal Lumber structure.

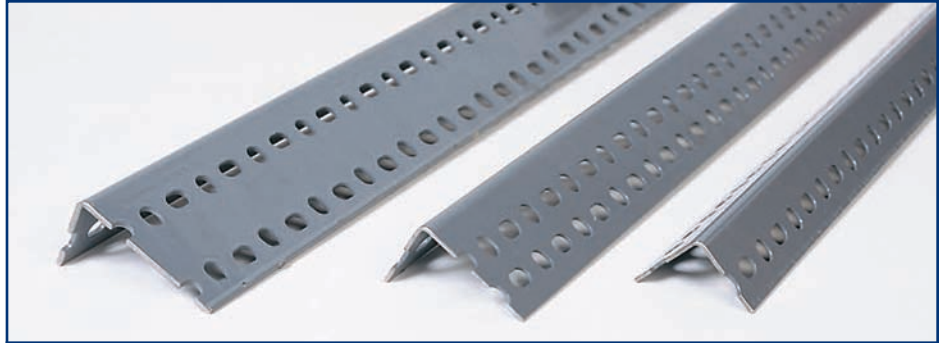

12 ga. 3"W

14 ga. 2 1/4"W

14 ga. 1 1/2"W

Metal Lumber Components

Description	W	D	H	Part Number
12 Gauge Metal Lumber Angles (package of 10 pieces)	3"	1 1/2"	120"	201001
	3"	1 1/2"	144"	201003
14 Gauge Metal Lumber Angles (package of 10 pieces)	2 1/4"	1 1/2"	120"	201000
	2 1/4"	1 1/2"	144"	201002
14 Gauge Metal Lumber Angles (package of 10 pieces)	1 1/2"	1 1/2"	120"	201004
	1 1/2"	1 1/2"	144"	201005
Connector Plate (Use with 3" & 2 1/4" w)	--	5 1/4"	7 1/4"	296101
Corner Brace (Use with 1 1/2" w)	--	--	--	296102
Extra Nuts and Bolts	5/16"	5/8"	--	2990001
	5/16"	3/4"	--	2990011
Metal Lumber Cutting Tool	--	--	--	299010

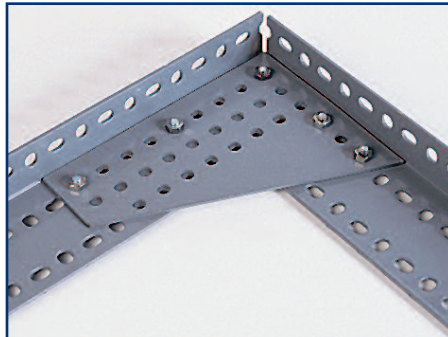

Connector Plate

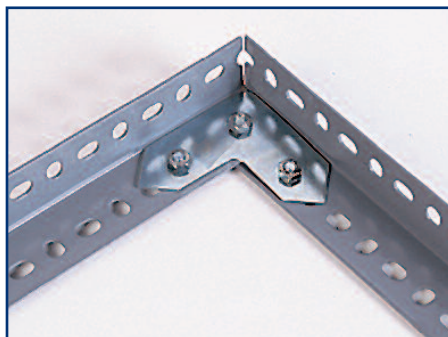

Corner Brace

Components are available from stock in color #50 Gray for shipment from any Republic location. Components in color #83 Decorator Tan are available from production.



#50 Gray



#83 Decorator Tan

Lockers

Qwik-Ship Lockers



Republic's most popular lockers are in stock for immediate shipment with our **Qwik-Ship Locker (QSL)** Program. Qwik-Ship Lockers feature rugged, heavy gauge steel doors mounted in welded frame assemblies for strength and durability. Our reliable and proven latching system ensures maximum security, while louvers provide necessary ventilation. Components are painted with a high-quality, baked enamel finish to provide years of protection against corrosion.

Qwik-Ship lockers are ideal for schools, businesses, hospitals, health clubs, sports and fitness facilities or any environment where personal storage is needed. Lockers are conveniently available in pre-packaged, 1-wide or 3-wide groupings. The program also offers a complete inventory of accessories for finished, professional-looking installations.

Lockers include 6" legs for an overall finished height of 78". All sizes shown are available from stock in color #83 Decorator Tan. Part numbers with an * are also available in color #50 Gray. Units ship K.D. (knocked down) from any Republic location. Assembly services are available for orders shipping from a Republic Regional Warehouse.

16-Person Multi-Robe

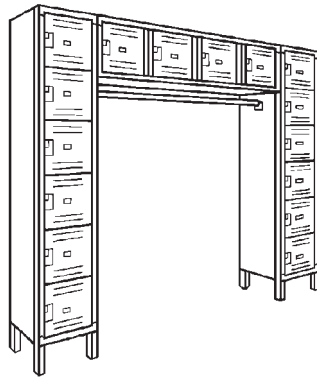

W	D	H	Part Number
72"	18"	72"	753945

Features

■ **Louvers** are provided on all Qwik-Ship lockers for ventilation.

■ The **recessed handle** is made of chrome plated die cast zinc. The handle case protects the lift trigger and serves as a padlock strike.

■ **Frame hooks** are made of heavy gauge steel. Rubber silencers are attached to frame hooks to soften the door slam.

■ The **box locker pull** provides a convenient finger pull and serves as a padlock strike and lock hole cover when padlocks are used.

■ **Number plates** feature 1/2" high black numerals on brushed aluminum. Specify number sequence when ordering lockers.



#50 Gray



#83 Decorator Tan

Single Tier Lockers



W	D	H	1-Wide	3-Wide
12"	12"	60"	753521*	753523
12"	15"	60"	753531	753533
12"	18"	60"	753541	753543
12"	12"	72"	753611	753613
12"	15"	72"	753621	753623
12"	18"	72"	753631*	753633*
15"	15"	72"	753651	753653
18"	18"	72"	753661	753663

Double Tier Lockers



W	D	H	1-Wide	3-Wide
12"	12"	30"	753701	753703
12"	12"	36"	753751*	753753*
12"	15"	36"	753761*	753763*
12"	18"	36"	753771*	753773*
15"	18"	36"	753791	753793

5-High Box Lockers

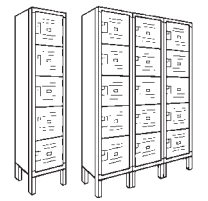

W	D	H	1-Wide	3-Wide
12"	12"	12"	753801*	753803*
12"	15"	12"	753811*	753813*

6-High Box Lockers



W	D	H	1-Wide	3-Wide
12"	12"	12"	753881*	753883*
12"	15"	12"	753891*	753893*
12"	18"	12"	753901*	753903*

QSL Accessories

Selected accessories for Qwik-Ship lockers are used to complete a locker installation.

■ 20 gauge **Closed Front and End Bases** are used to close the bottom area between locker legs.



Front Bases		
W	H	Part Number
12"	6"	7505002*
15"	6"	7505005
18"	6"	7505008
End Bases (single row)		
D	H	Part Number
12"	6"	7502613*
15"	6"	7502614*
18"	6"	7502615*

■ **Recess Trim** is used to cover the gap between lockers and walls in a recessed installation. Trim has a 3" face and a 3/8" top return. Integral corner caps and hair-line joints have a clean look.



Recess Trim Kit		
W	H	Part Number
72"	78"	753971
Kit includes 1 - 72" piece top trim, 1 - 78" piece RH side trim, 1 - 78" piece LH side trim.		
Top Trim Kit		
W	H	Part Number
72"	--	753972
Kit includes 4 - 72" pieces top trim.		

■ **Individual Sloping Tops** provide a finished appearance and discourage the use of locker tops as storage areas. The rise is 1/3 of the locker depth.

■ Order **End Panels** for use with Sloping Tops. One end panel is required for each locker, plus one for each group.



Individual Sloping Tops		
W	D	Part Number
12"	12"	7518401*
12"	15"	7518406*
12"	18"	7518411*
15"	18"	7518412
18"	18"	7518413*
Sloping Top End Panel		
W	D	Part Number
--	12"	7518440*
--	15"	7518441*
--	18"	7518442*

■ **Corner Angles, Angle Fillers and Slip Joint Fillers** are used to fill open areas or corners between individual lockers.

Corner Angle		
W	H	Part Number
--	78"	7505097
Angle Filler		
W	H	Part Number
6"	78"	7520826
12"	78"	7520828
Slip Joint Filler		
W	H	Part Number
--	78"	7520804

■ Republic offers a full range of **built-in combination locks, key locks, padlocks, and electronic locking systems**. Call Canton for more information.

All items shown are available from stock in #83 Decorator Tan. Part numbers with an * are also available in #50 Gray.



#50 Gray



#83 Decorator Tan

■ **Benches and Pedestals** have an overall height of 17 1/2". Bench tops are 9 1/2" wide by 1 1/4" full finished thickness laminated maple. Pedestals consist of sturdy 1 1/4" diameter tubing with 10 gauge steel flanges welded to each end.

■ **Moveable Benches** consist of maple bench tops mounted to free standing trapezoid shaped pedestals. Pedestals are made from 1/4" x 3" aluminum bar stock and feature a black anodized finish. Non-skid pads are provided for each pedestal.



Standard Bench Pedestal	
H	Part Number
16 1/4"	7107529*
Movable Bench Pedestal	
H	Part Number
16 1/4"	7107650
Bench Tops	
W	Part Number
3'	702063
4'	702064
5'	702065
6'	702066
7'	702067
8'	702068
9'	702069
10'	702070
11'	702071
12'	702072

Lockers





PDQ Lockers

The **PDQ Locker** Program allows you to get Republic's most popular Standard, Quiet, and MVP Sports Lockers in just three weeks.



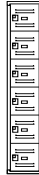

The program is specifically designed for quick turn around on small to medium sized production locker requirements. Combinations of one starter unit and multiple adders are used to build locker groups.

Locker door/frame assemblies may be ordered in any of the 25 standard spray finish colors. Standard and Quiet Locker body parts are supplied in #83 Tan only. MVP body

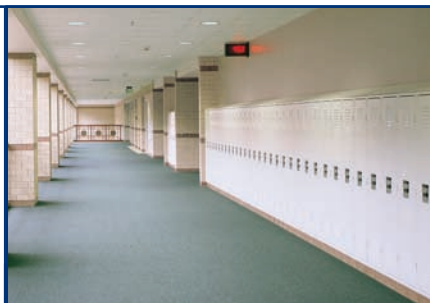
parts are supplied in the door/frame color. Lockers are available in "leg" or "no leg" configurations. MVP legs are 4"; all others are 6". **Standard Lockers are supplied with louvers.** **Quiet Lockers are supplied without louvers.** A full line of trim and accessories is available to complement PDQ lockers. Contact Republic for specific details.

Standard Lockers					
Single Tier Lockers					
W	D	H		Starter	Adder
12"	12"	60"		730100	730101
12"	15"	60"		730102	730103
12"	18"	60"		730104	730105
12"	12"	72"		730150	730151
12"	15"	72"		730152	730153
12"	18"	72"		730154	730155
Double Tier Lockers					
W	D	H		Starter	Adder
12"	12"	30"		730240	730241
12"	15"	30"		730242	730243
12"	18"	30"		730244	730245
12"	12"	36"		730290	730291
12"	15"	36"		730292	730293
12"	18"	36"		730294	730295
Triple Tier Lockers					
W	D	H		Starter	Adder
12"	12"	24"		730410	730411
12"	15"	24"		730412	730413
12"	18"	24"		730414	730415
Six High Box Lockers					
W	D	H		Starter	Adder
12"	12"	12"		730900	730901
12"	15"	12"		730902	730903
12"	18"	12"		730904	730905



Quiet Lockers					
Single Tier Lockers					
W	D	H		Starter	Adder
12"	12"	60"		732100	732101
12"	15"	60"		732102	732103
12"	18"	60"		732104	732105
12"	12"	72"		732150	732151
12"	15"	72"		732152	732153
12"	18"	72"		732154	732155
Double Tier Lockers					
W	D	H		Starter	Adder
12"	12"	30"		732240	732241
12"	15"	30"		732242	732243
12"	18"	30"		732244	732245
12"	12"	36"		732290	732291
12"	15"	36"		732292	732293
12"	18"	36"		732294	732295
Triple Tier Lockers					
W	D	H		Starter	Adder
12"	12"	24"		732410	732411
12"	15"	24"		732412	732413
12"	18"	24"		732414	732415



Lockers

MVP Lockers



MVP Basic

W	D	H	Starter	Adder
24"	18"	72"	771200	771202
24"	24"	72"	771208	771210



MVP w/Compartment

W	D	H	Starter	Adder
24"	18"	72"	771248	771250
24"	24"	72"	771256	771258



MVP w/Foot Locker

W	D	H	Starter	Adder
24"	18"	72"	771296	771298
24"	24"	72"	771304	771306



MVP Complete

W	D	H	Starter	Adder
24"	18"	72"	771344	771346
24"	24"	72"	771352	771354



44
Country
Blue



50
Gray



51
Taupe



52
Canyon



53
Sun
Yellow



54
Wood
Violet



55
Burgundy



61
Midnight
Blue

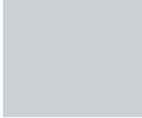

62
Shadow
Gray



65
Orange



66
Hunter
Green



67
Blueberry



70
Sea
Green



71
Marine
Blue



73
Cosmos



79
Minute
Man
Blue



80
Crystal
Cave

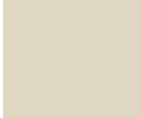

81
Alabaster



82
Red
Velvet



83
Decorator
Tan

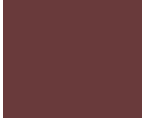

84
Mulled
Wine



85
True
Navy



89
Cork



93
White
Mist



94
Jet
Black



Republic Storage Systems, LLC

Corporate Headquarters:
1038 Belden Ave NE
Canton, OH 44705

Regional Warehouse Locations:
Statesville, NC 28677
Reno/Sparks, NV 89431

800-477-1255

Catalog available online at
www.republicstorage.com

For more information on ordering, payment terms, shipment routing, return policy or price, contact Republic or a Republic Authorized Distributor. Republic®, Wedge-Lock®, Metal Lumber® and Mondrian® are registered trademarks of Republic Storage Systems, LLC. All product information, terms and conditions in this catalog are subject to change without notice. No part of this document may be reproduced without written permission from Republic Storage Systems, LLC.

Copyright ©2007 Republic Storage Systems, LLC.

